

White paper

RC223 (type B) residual-current release

RC223 (type B) residual current release

Index

1. Generals	2
2. Application description	3
2.1 Applications	3
2.2 Application examples.....	4
2.3 How does an RC223 operate?	6
3. Application indications	7
3.1 Technical characteristics	7
3.2 Configuration indications	7
3.3 Emergency Arrest (EA).....	7
3.4 Operating time and current	8
3.5 "Testing field" section	8

1. Generals

The RC223 residual current release, which can be combined with the Tmax T3, T4 four-pole circuit-breakers in the fixed or plug-in version, is the most advanced solution in the whole residual current release family for the Tmax range.

It can boast conformity with Type B operation, which guarantees sensitivity to residual fault currents with alternating, alternating pulsating and direct current components.

Apart from the signals and settings typical of the “basic” residual current release, RC223 also allows the selection of the maximum threshold of sensitivity at the residual fault frequency (3 steps $f_e = 400 - 700 - 1000$ Hz).

It is therefore possible to adapt the residual current device to the different requirements of the industrial plant according to the prospective fault frequencies generated on the load side of the release.

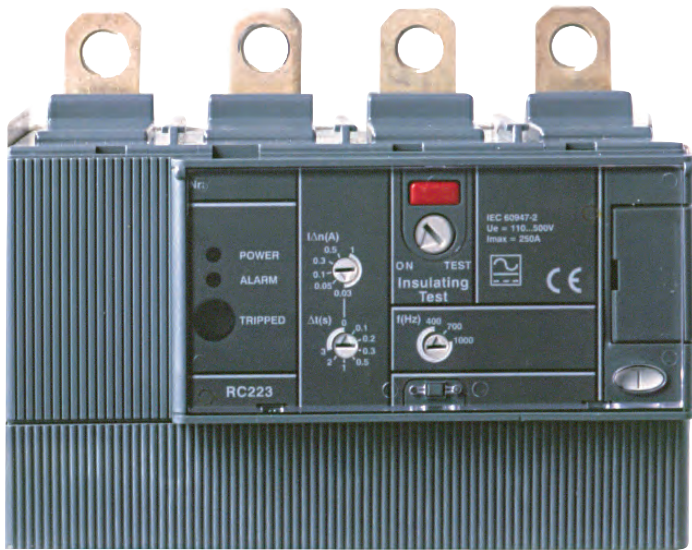

	Form of residual current	Correct functioning of residual current devices		
		Type	A	B
Sinusoidal ac	suddenly applied	AC	+	+
	slowly rising	+	+	+
Pulsating dc	suddenly applied			
	with or without $\uparrow 0.006$ A slowly rising		+	+
Smooth dc				+

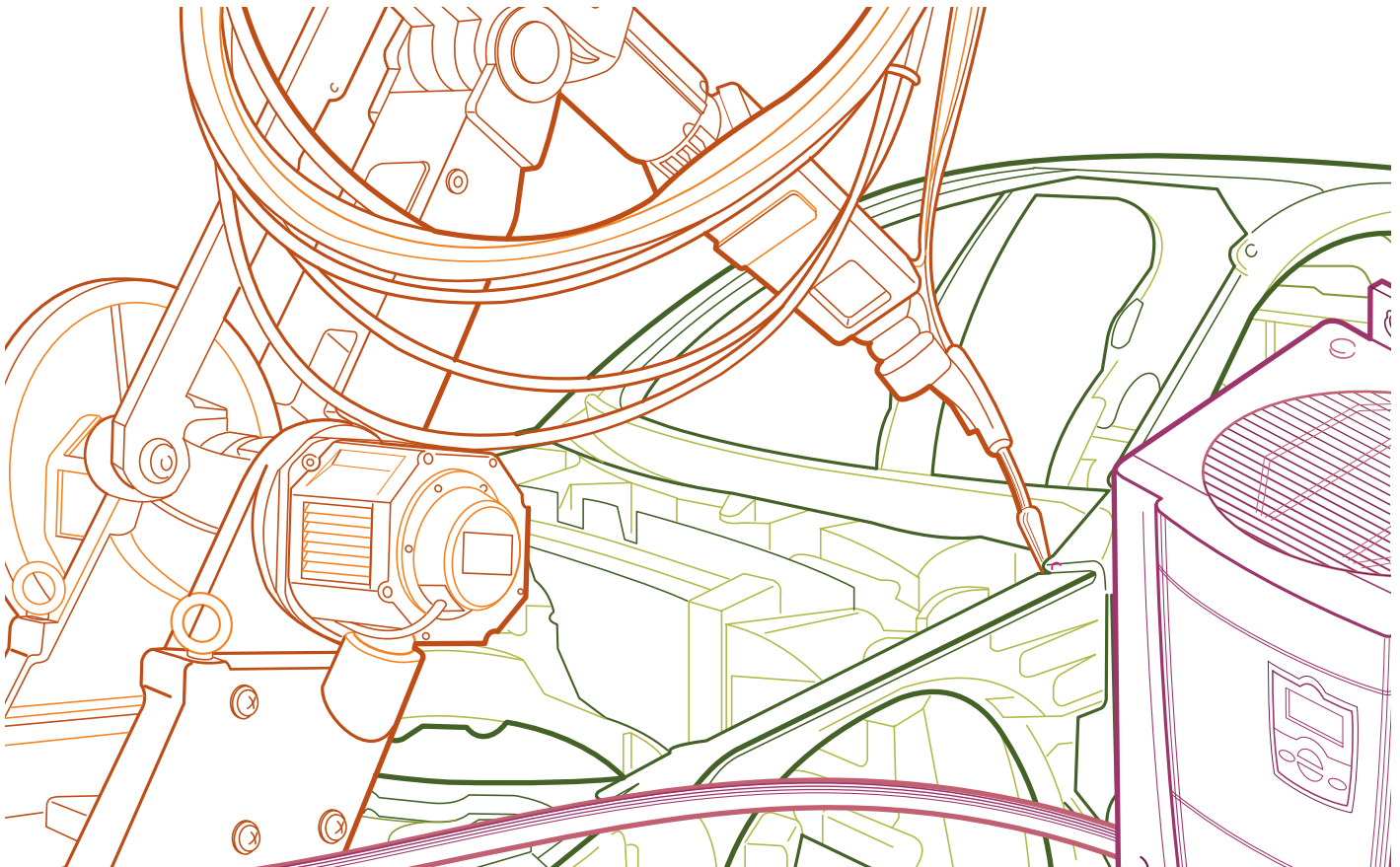

2. Application Description

2.1 Applications

Single-phase user devices, such as uninterruptible power supplies (UPS), PCs, printers, cash registers, electro medical equipment etc. mounting electronic circuits in alternating current, in case of earth fault, generate currents with direct components. Analogously, three-phase users as, for instance, UPS, computed tomography (CT) equipment, nuclear magnetic resonance (NMR) equipment, variable speed drives and AC/DC converters in case of earth faults, generate such direct currents that the functioning of the residual current devices (RCDs) placed to protect the relevant supply circuits could be jeopardized.

In these cases, since these fault currents to earth are not necessarily detected by the toroid of type AC residual current devices, type A residual current devices are chosen for single-phase users and type B for three-phase users.

In fact, in case there is a three-phase drive (constituted by a rectifier and an inverter as shown in the figure) to run an asynchronous motor at variable speed, the earth fault can occur both in the direct current section as well as in the section on the load side of the inverter. In this last case, high frequency earth fault currents are generated with high harmonic content; therefore they can be detected only by a type B residual current device.

In photovoltaic installations, if the PV supply system does not have at least a simple segregation between the AC side and the DC side, the residual current device installed to provide protection against indirect contacts by means of automatic tripping shall be of type B (IEC 60364-712).

Analogously, the Standard EN 62040-1 prescribes that protection of UPS against earth faults is carried out by residual current circuit-breakers of type B (for three-phase UPS) and of

type A (for single-phase UPS) when the UPS project contemplates the possibility of an earth fault current with direct current components.

Besides, given a mobile electronic equipment with power > 4 kVA or a fixed one generating a reduced-ripple fault direct current, when a residual current device is used for the protection against direct and indirect contacts, on the supply side of the apparatus itself exclusively the use of a type B RCD (EN 50178) is accepted.

Therefore, a residual current device type B is used for tripping (see IEC/TR60755):

- as a type A (sinusoidal currents at 50-60 Hz and unidirectional pulsating currents);
- for residual alternating currents superimposed on a smooth direct current of 0.4 times the rated residual current $I_{\Delta n}$;
- for residual pulsating currents superimposed on a smooth direct current of 0.4 times the rated residual current $I_{\Delta n}$ or 10mA, whichever is the highest value;
- for residual currents which may result from rectifying circuits, i.e.:
 1. two-pulse bridge connection line to line for 2-, 3- and 4-pole devices;
 2. single-phase bridge connected to a capacitive load, determining pulsating smooth direct currents;
 3. three-pulse star connection or six-pulse bridge connection for 3- and 4-pole devices;
- for residual smooth direct currents.

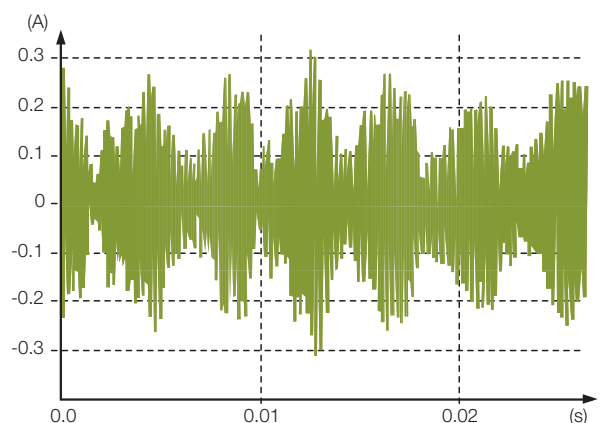
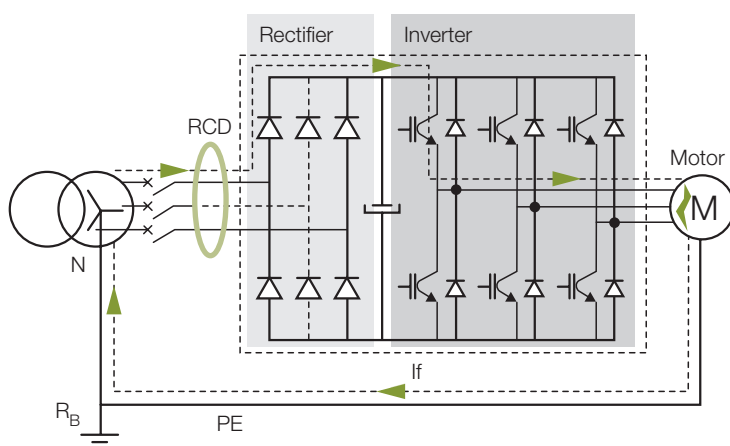

2. Application Description

2.2 Application examples

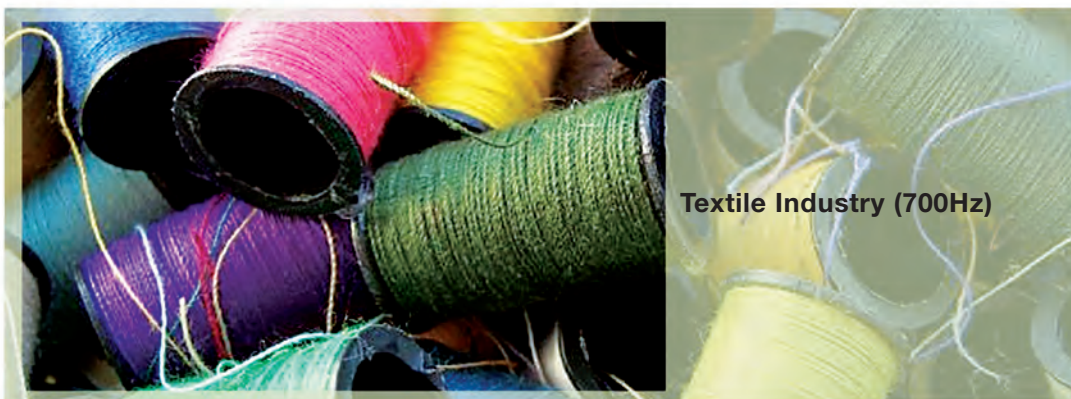
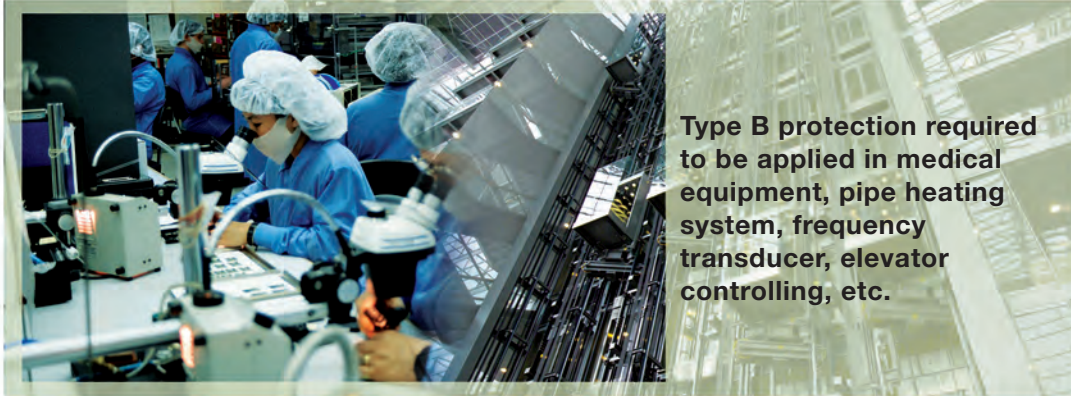

DC



I_n up to 250A
U_e up to 500Vac
F = 50/60Hz

Fe=1000Hz











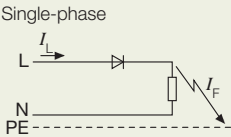

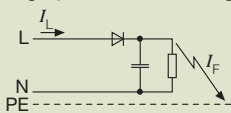

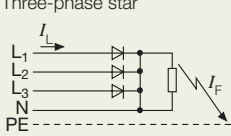
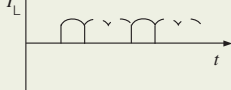
Frequency
Converting
System

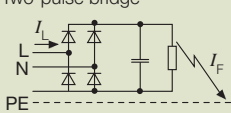
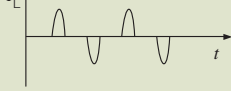
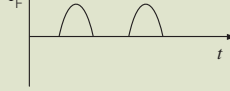
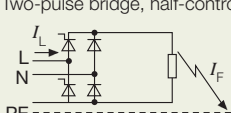
Fe=700Hz

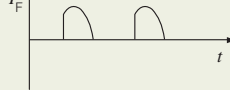
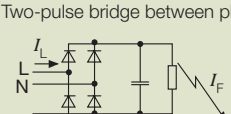
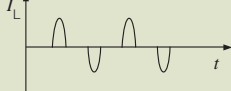
Fe=400Hz

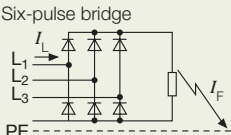
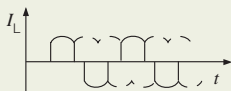
The following table shows some typical applications with power electronics, where type B residual current devices can be used; in particular, they are necessary in the examples 2-3-

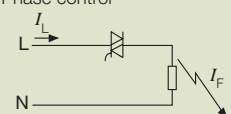
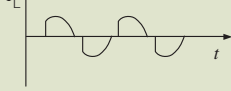
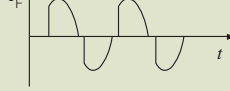
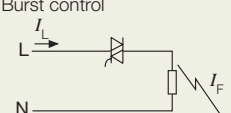
6-7 because of the predominant presence of the direct component which could not be detected by type A-AC residual current devices.

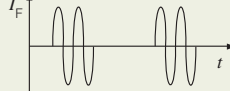
			Connection	Normal mains current	Earth fault current
A or B	RC221 RC222 RC223	1	Single-phase 		
B	RC223	2	Single-phase with smoothing 		
B	RC223	3	Three-phase star 		
A or B	RC221 RC222 RC223	4	Two-pulse bridge 		
A or B	RC221 RC222 RC223	5	Two-pulse bridge, half-controlled 		
B	RC223	6	Two-pulse bridge between phases 		
B	RC223	7	Six-pulse bridge 		
AC or A or B	RC221 RC222 RC223	8	Phase control 		
AC or A or B	RC221 RC222 RC223	9	Burst control 		

2. Application Description

2.3 How does an RC223 operate?

All the active conductors of the supply circuit to be monitored (except for the protection conductor) are encircled by the residual current toroid, as in type AC and A residual current devices.

Nevertheless, in type B residual current devices type RC223, keeping a single toroid, a special method of operation and measuring is used for the detection of direct and alternating currents.

The toroid is no more used passively, by reading only the current induced as in the case of types AC and A, but it is supplied by a voltage with rectangular waveform and kHz frequency. Such voltage generates in the winding an alternating current whose waveform is shown in the figure below.

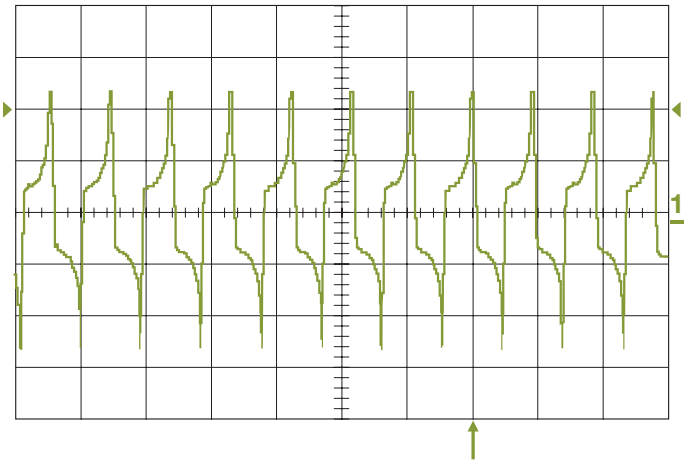

A resistance in series with the winding creates a voltage drop, whose value is sent to a microprocessor including a low-pass filter.

If there is a fault residual current, it shall cause a variation of the waveform of the current detected as it can be seen in the figure below.

The spectrum of such waveform shall be therefore formed by some lines at the fundamental frequency and at its multiples and some lines at the fault frequency. By low-pass filtering it will be possible to detect the fault component even if it is direct.

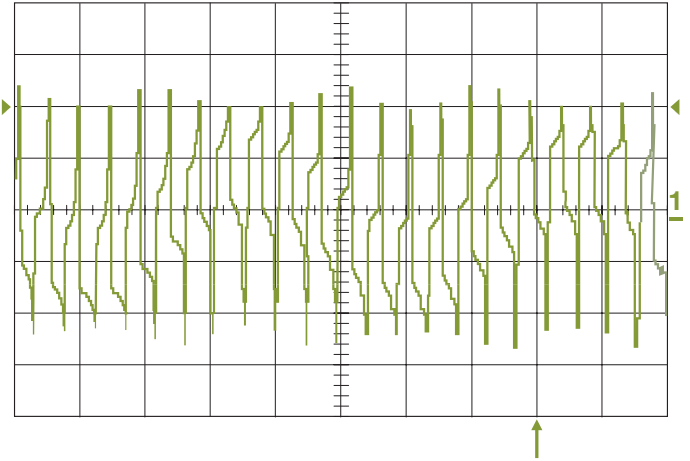

3. Application Indications

3.1 Technical characteristics

Size	T3 and T4 4p	
Type	B	
Primary service voltage	[V]	110...500
Rated frequency	[Hz]	45...66
Earth fault frequency	[Hz]	0-400-700-1000
Rated service current	[A]	up to 250 A
Trip threshold - rated residual current	[A]	0.03-0.05-0.1-0.3-0.5-1
Time limit for non-trip at 2·I _{Δn}	[s]	inst-0.1-0.2-0.3-0.5-1-2-3
Tolerance over trip time	±20%	
Absorbed power	<10W @ 400V	

Note: RC223 for Tmax T3 CB has a limitation in the rated current equal to 225A, which is consequently the maximum current threshold which can be set on the CB.

The RC223 rated frequency is always 50-60 Hz; by selecting 400-700-1000 Hz, the device becomes sensitive to the detection of the fault currents up to these frequencies.

3.2 Configuration indications

LED:

- 7 blinks in 3.5s → Internal supply error
- 6 blinks in 3s → Current sensor error
- 5 blinks in 3s → YO2 broken cable or YO2 without cable
- 3 blinks in 2.5s → YO2 bloked
- 1 blink in 2.5s → SO open

- light fixed → PreAlarm
- continuous blinking → Alarm or CB tripped

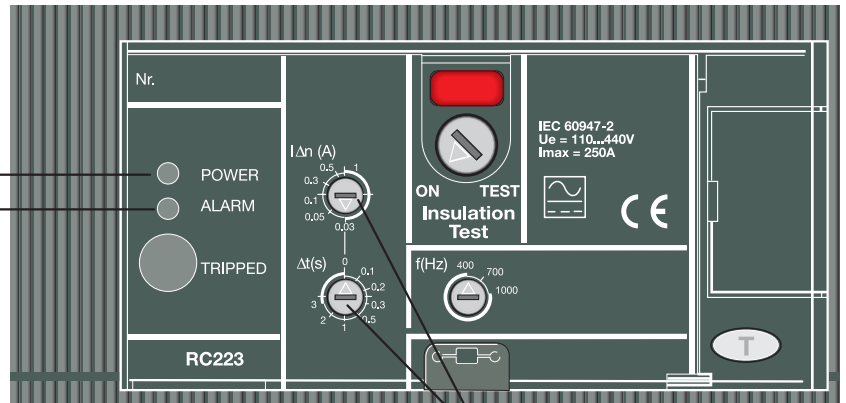

- I_{Δn}: 1) 0.03 A → Δt = 0 s ONLY
- 2) 0.05 ÷ 1 A → Δt = 0 ÷ 3 s max

For installation and more information please refer to the indications of RC22X (1SDH000436R0507)

Pre-Alarm: When the residual fault current turns up and the value is higher than 25% of the setup threshold I_{Δn}, the LED is lit up fixed.

Alarm (Trip): When the residual fault current value is higher than 75% of the setup threshold I_{Δn} (with I_{Δn}=0.03A for human protection, the fault should be higher than 90% of the setup one), the LED blinks, and the opening release connected to RC223 will trip according to the setup time delay Δs(s).

By setting I_{Δn} and Δt (non-trip time) it is possible to achieve time-current selectivity with other devices in series.

However, setting a rated residual current of 30mA, the intentional delay is null (as indicated in the Std. IEC 60947-2 Annex B) since it can be used also as additional protection against direct contact.

3.3 Emergency Arrest (EA)

RC223 residual current device associates to the residual current protections the emergency arrest function for remote opening.

In comparison with the devices commonly used in the emergency circuits, RC223 offers the advantages of a positive safety (since the accidental break of the circuit is equivalent to an action on the emergency pushbutton) and of absence of unwanted trips in case of reduction or temporary interruption of the network voltage.

The action on the emergency button connected to the residual current device causes a variation of the logic level which is read by the microprocessor controlling the shunt opening release.

3. Application Indications

3.4 Operating time and current

The following diagrams show the tripping times of RC223 as a function of the residual current and taking as parameter the time delay set; the tripping times are useful above all when ever wishing to carry out a selectivity study between residual current devices.

Maximum tripping time RC223

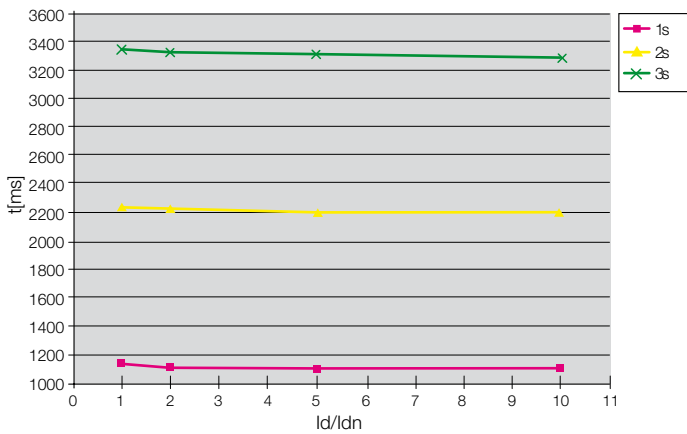
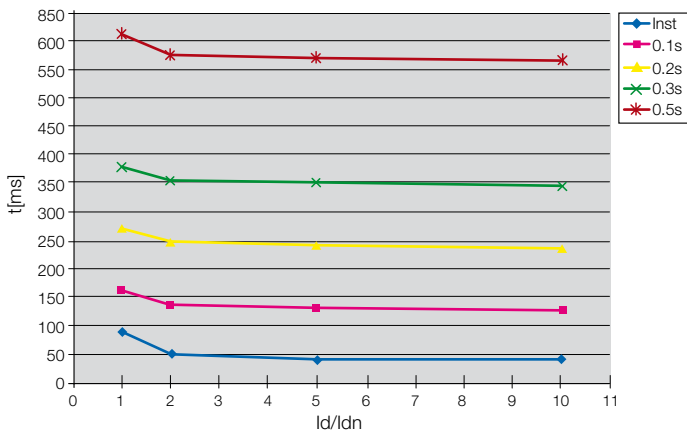

3.5 "Testing field" section

According to the Std. IEC 60947-2 (clause 8.3.3.2), the circuits incorporating solid-state devices connected to the main circuit shall be disconnected from the supply for the test of the dielectric properties of the circuit-breaker.

In case of the RC223, this device has to be disconnected before the test and connected again after it as shown in the following figure.

The insulation test is carried out with the trip coil disconnected.

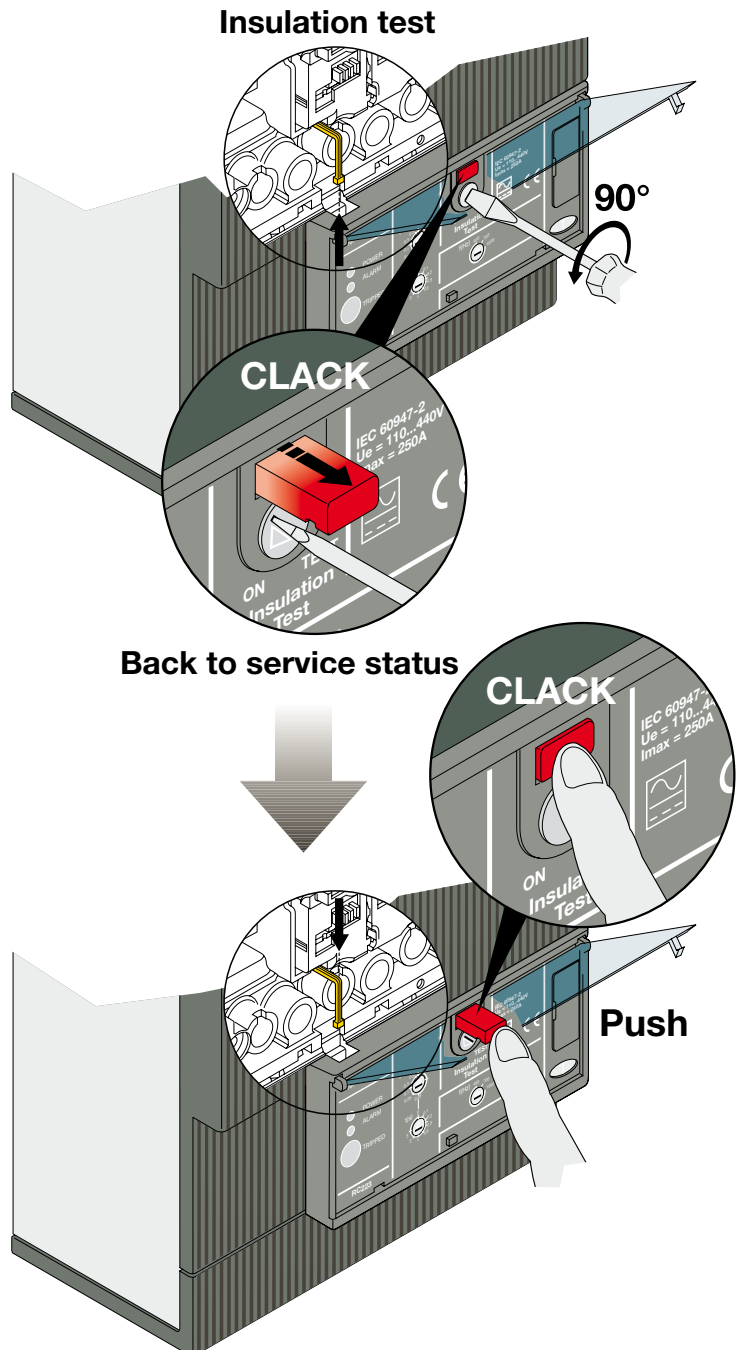

Contact us

ABB SACE

A division of ABB S.p.A.

L.V. Breakers

Via Baioni, 35

24123 Bergamo - Italy

Tel.: +39 035 395 111

Fax: +39 035 395306-433

www.abb.com

The data and illustrations are not binding. We reserve the right to modify the contents of this document on the basis of technical development of the products, without prior notice.

Copyright 2009 ABB. All rights reserved.

1SDC007404G0201 - 10/2009