

White paper

## Working with the Trip Characteristic Curves of ABB SACE Low Voltage Circuit-Breakers

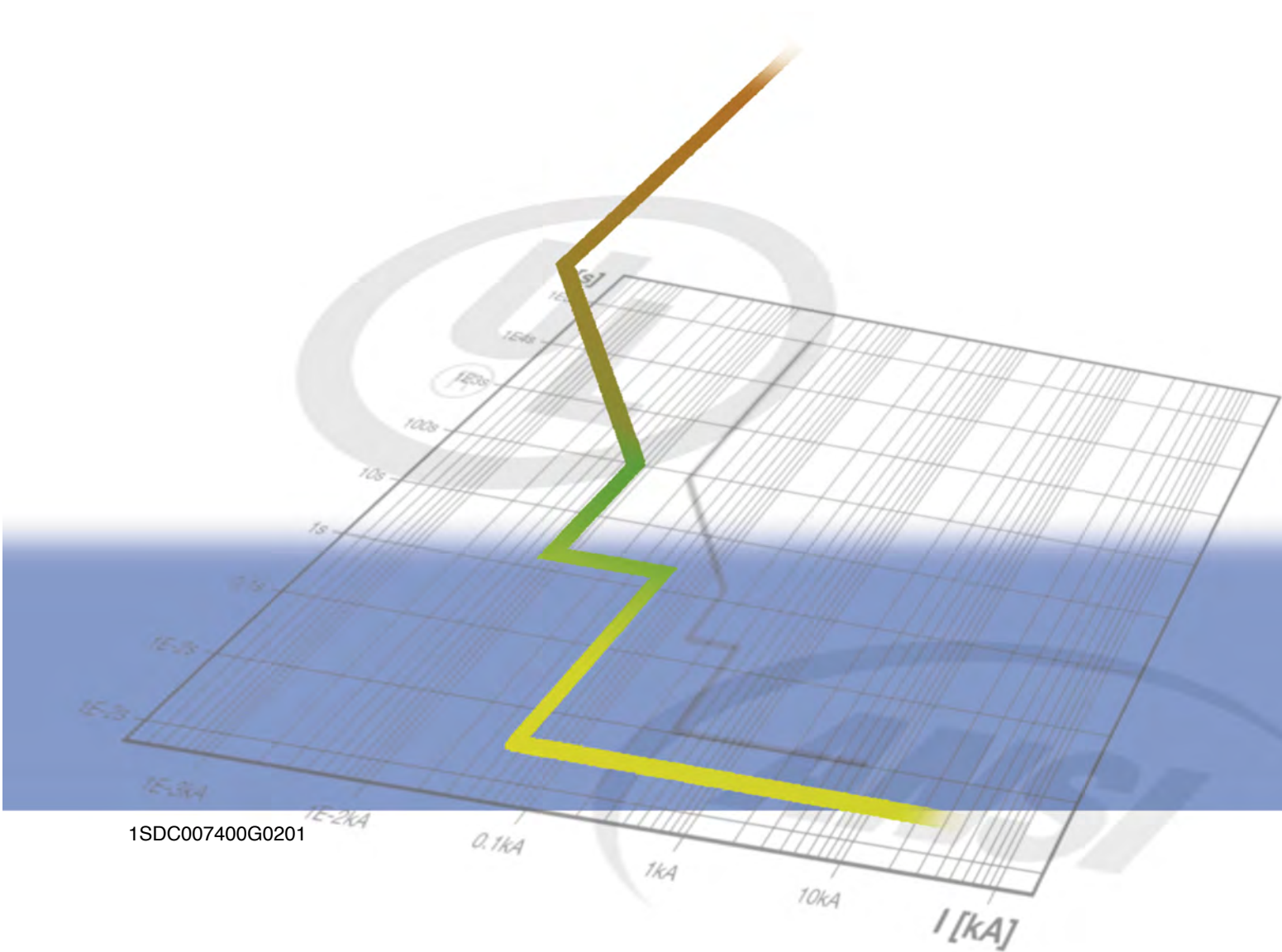

1SDC007400G0201

**ABB**



# Index

<b>1. Introduction</b> .....	2
<b>2. Main Definitions</b> .....	3
<b>3. ABB SACE Low Voltage Circuit Breakers complying with the Standards UL 489 and UL 1066</b>	
<b>3.1</b> Generalities on Low Voltage Circuit Breakers.....	7
<b>3.2</b> ABB SACE Low Voltage Circuit Breakers .....	8
3.2.1 Molded-Case Circuit Breakers (Tmax) .....	8
3.2.2 Low Voltage Power Circuit Breakers (Emax) .....	10
<b>4. Thermomagnetic and Electronic Trip Units for ABB SACE Circuit Breakers</b>	
<b>4.1</b> Thermomagnetic Trip Units.....	12
4.1.1 Overload Protection (L).....	12
4.1.2 Instantaneous Short Circuit Protection (I).....	12
4.1.3 Thermomagnetic Trip Units for Tmax Circuit Breakers .....	13
4.1.3.1 Time-Current Curve of a Thermomagnetic Trip Unit TMA .....	14
4.1.3.2 Setting Examples of a Trip Unit TMA .....	15
<b>4.2</b> Electronic Trip Units.....	16
4.2.1 Overload Protection (L).....	16
4.2.2 Short-Circuit Protection with Delayed Trip (S) .....	17
4.2.3 Instantaneous Short-Circuit Protection (I) .....	19
4.2.4 Ground-Fault Protection (G) .....	20
4.2.5 Electronic Trip Units for Tmax Circuit Breakers .....	21
4.2.5.1 Setting Examples of a Trip Unit PR222DS .....	22
4.2.6 Electronic Trip Units for Emax Circuit Breakers .....	24
<b>5. Trip Curves of ABB SACE Trip Units</b>	
<b>5.1</b> Trip Curves of Thermomagnetic Trip Units .....	25
<b>5.2</b> Trip Curves of Electronic Trip Units .....	26
5.2.1 Functions L and S.....	26
5.2.2 Function I.....	29
5.2.3 Function G.....	30
<b>6. Curves of Current Limiting Circuit Breakers: Let-Through Values of <math>I^2t</math> and Peak Current</b> .....	32
<b>Annex A: Tolerance in the Trip Curves</b> .....	35
<b>Glossary</b> ..	36

## 1. Introduction

This White Paper is aimed at making easier the reading and the interpretation of the characteristic curves (trip curves, specific let-through energy curves and limitation curves) of the Molded-Case Circuit Breakers (MCCBs) and Low Voltage Power Circuit Breakers (LVPCBs) manufactured by ABB SACE in compliance with the following American Standards:

- UL 489: Molded-Case Circuit Breakers, Molded-Case Switches and Circuit Breaker Enclosures
- UL 1066: Low-Voltage AC and DC Power Circuit Breakers Used in Enclosures
- ANSI C37.13: IEEE Standard for Low-Voltage AC Power Circuit Breakers Used in Enclosures
- ANSI C37.16: Low-Voltage Power Circuit Breakers and AC Power Circuit Protectors. Preferred Ratings, Related Requirements, and Application Recommendations
- ANSI C37.17: American National Standard for Trip Devices for AC and General Purpose DC Low Voltage Power Circuit Breakers

This publication is mainly divided into four parts.

The first introductory part (Chapters 1 and 2) describes the purposes of this White Paper and reports all the definitions useful for its comprehension.

The second part (Chapter 3) offers a scenario of ABB SACE industrial circuit breakers manufactured in compliance with the requirements of the UL Standards. The third part (Chapter 4) describes the trip units of ABB SACE circuit breakers and the associated characteristic trip curves.

Finally, the fourth and last part (Chapters 5 and 6) reports some reading examples of curves to help the reader in the comprehension and interpretation of the information they contain.

## 2. Main Definitions

Hereunder are the main definitions extracted from the Standards UL 489, UL 1066, ANSI C37.13 and ANSI C37.17, useful to better understand the contents of this document.



### Definitions from the Standard UL 489

- 1 - ADJUSTABLE CIRCUIT BREAKER: a circuit breaker that has adjustable time/current tripping characteristics. These may include:
  - a) Inverse-time (such as continuous current, long time, and/or short time);
  - b) Instantaneous;
  - c) Ground-fault.
- 2 - ADJUSTABLE INSTANTANEOUS RELEASE (TRIP): that part of an overcurrent trip element that can be adjusted to trip a circuit breaker instantaneously at various values of current within a predetermined range of currents.
- 3 - CIRCUIT BREAKER: a device designed to open and close a circuit by non-automatic means, and to open the circuit automatically on a predetermined overcurrent, without damage to itself when properly applied within its rating.
- 4 - CIRCUIT BREAKERS WITH GROUND-FAULT PROTECTION FOR EQUIPMENT: circuit breakers that perform all normal circuit breaker functions and also trip when a fault current to ground exceeds a predetermined value.
- 5 - CURRENT-LIMITING CIRCUIT BREAKER: one that does not employ a fusible element and, when operating within its current-limiting range, limits the let-through  $I^2t$  (see definition 20 AMPERES SQUARED SECONDS) to a value less than the  $I^2t$  of a 1/2-cycle wave of the symmetrical prospective current.

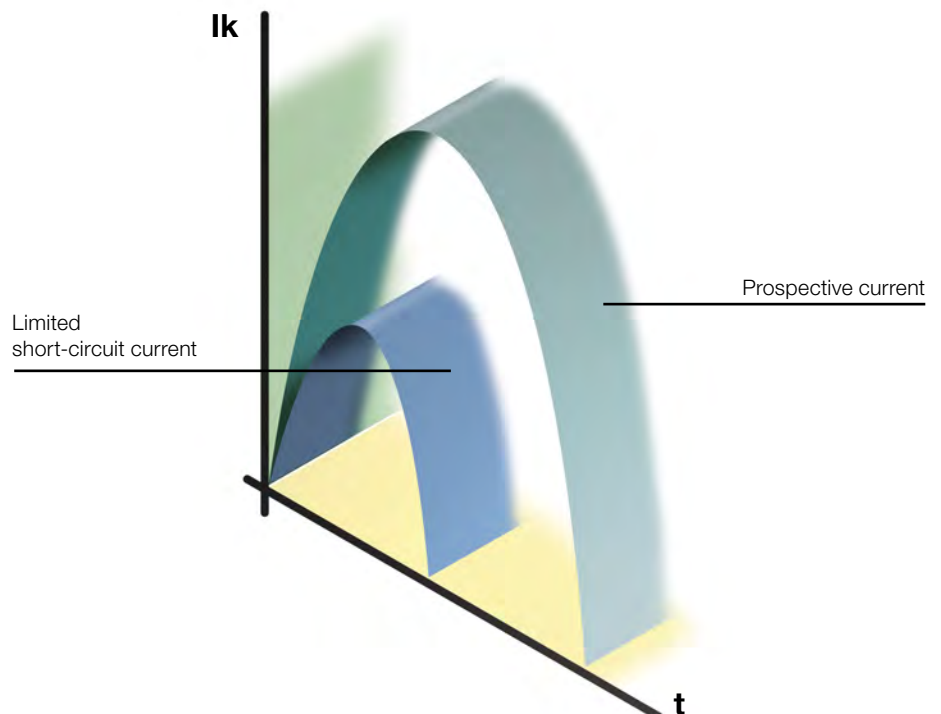

- 6 - CURRENT-LIMITING RANGE: the RMS symmetrical prospective currents between the threshold current and the maximum interrupting rating current.
- 7 - CURRENT SETTING ( $I_r$ ): the RMS current an adjustable circuit breaker is set to carry continuously without tripping. It is normally expressed as a percentage of the rated current and is adjustable.
- 8 - FIXED INSTANTANEOUS RELEASE (TRIP): that part of an overcurrent release element which contains a nonadjustable means that is set to trip a circuit breaker instantaneously above a predetermined value of current.
- 9 - FRAME: an assembly consisting of all parts of a circuit breaker except an interchangeable trip unit.
- 10 - FRAME SIZE: a term applied to a group of circuit breakers of similar physical configuration. Frame size is expressed in amperes and corresponds to the largest ampere rating available in the group. The same frame size designation may be applied to more than one group of circuit breakers.
- 11 - GROUND-FAULT DELAY: an intentional time delay in the tripping function of a circuit breaker when a ground-fault occurs.
- 12 - GROUND-FAULT PICKUP SETTING: the nominal value of the ground-fault current at which the ground-fault delay function is initiated.
- 13 - INSTANTANEOUS OVERRIDE: a fixed current level at which an adjustable circuit breaker will override all settings and will trip instantaneously.
- 14 - INSTANTANEOUS PICKUP SETTING: the nominal value of current that an adjustable circuit breaker is set to trip instantaneously.
- 15 - INSTANTANEOUS TRIP: a qualifying term indicating that no delay is purposely introduced in the automatic tripping of the circuit breaker.
- 16 - INSTANTANEOUS TRIP CIRCUIT BREAKER (MOTOR CIRCUIT PROTECTOR OR CIRCUIT INTERRUPTER): is one intended to provide short circuit protection only. Although acting instantaneously under short circuit conditions, these circuit breakers are permitted to include a transient dampening action to ride through initial motor transients.
- 17 - INTERCHANGEABLE TRIP UNIT: one which can be interchanged by a user among circuit breaker frames of the same design (to see also definition 32 RATING PLUG).
- 18 - INTERRUPTING RATING: the highest current at rated voltage that a device is intended to interrupt under standard test conditions.
- 19 - INVERSE TIME: a qualifying term indicating that there is a purposely introduced delayed tripping in which the delay decreases as the magnitude of the current increases.
- 20 -  $I^2t$  (AMPERES SQUARED SECONDS): an expression related to the circuit energy as a result of current flow. With respect to circuit breakers, the  $I^2t$  [A<sup>2</sup>s] is expressed for the current flow between the initiation of the fault current and the clearing of the circuit.
- 21 - LONG-TIME DELAY: an intentional time delay in the overload tripping of an adjustable circuit breaker's inverse time characteristics. The position of the long time portion of the trip curve is normally referenced in seconds at 600 percent of the current setting ( $I_r$ ).
- 12 - LONG-TIME PICKUP: the current at which the long-time delay function is initiated.
- 13 - MOLDED-CASE CIRCUIT BREAKER: a circuit breaker which is assembled as an integral unit in a supportive and enclosed housing of insulating material.

- 24 - **OVERCURRENT**: Any current in excess of the rated current of equipment or the ampacity of a conductor. It may result from overload, short-circuit, or ground-fault.
- 25 - **OVERLOAD**: Operation of equipment in excess of normal, full-load rating or of a conductor in excess of rated ampacity that, when it persists for a sufficient length of time, would cause damage or dangerous overheating.
- 26 - **PEAK CURRENT**: the maximum instantaneous current that flows in a circuit.

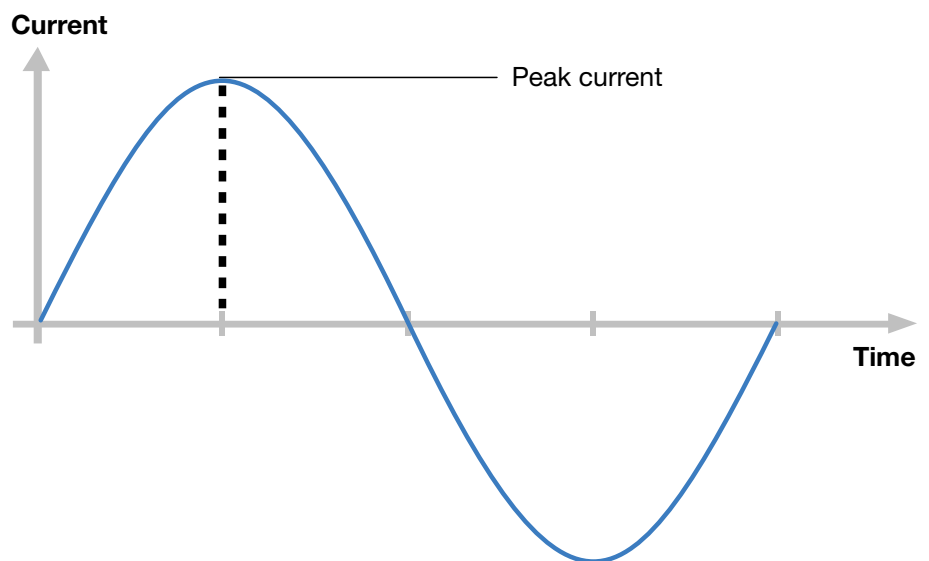

- 27 - **PROSPECTIVE CURRENT (AVAILABLE CURRENT)**: the current that which would flow in a circuit if a short circuit of negligible impedance were to occur at a given point.
- 28 - **RATED CURRENT ( $I_n$ )**: the marked current rating and the maximum RMS current a circuit breaker can carry continuously without tripping and the maximum current the circuit breaker will carry without changing, deleting, or adding a part or parts such as trip units and rating plugs. See also current setting ( $I_r$ ).
- 29 - **RATED FREQUENCY**: the service frequency of the circuit for which the circuit breaker is designed and tested.
- 30 - **RATED VOLTAGE**: the rated voltage is the nominal RMS voltage for which the circuit breaker is designed to operate.
- 31 - **RATING**: the designated limit or limits of the rated operating characteristic(s) of a device.
- 32 - **RATING PLUG**: a self-contained portion of a circuit breaker that is interchangeable and replaceable in a circuit breaker trip unit by the user. It sets the **RATED CURRENT ( $I_n$ )** of the circuit breaker.
- 33 - **SHORT CIRCUIT**: An abnormal connection (including an arc) of relatively low impedance, whether made accidentally or intentionally, between two points of different potential.

- 34 - SHORT CIRCUIT CURRENT RATING: the maximum RMS prospective (available) current to which a device can be connected when protected by the specified overcurrent protective devices. The rating is expressed in amperes and volts.
- 35 - SHORT-TIME DELAY: an intentional time delay in the tripping of a circuit breaker between the overload and the instantaneous pickup settings.
- 36 - SHORT-TIME PICKUP: the current at which the short-time delay function is initiated.
- 37 - THRESHOLD CURRENT – the RMS symmetrical prospective current at the threshold of the current limiting range, where:
- the peak current let-through in each phase is less than the peak of that symmetrical prospective current, and
  - the  $I^2t$  in each phase is less than the  $I^2t$  of a 1/2 cycle wave of the symmetrical prospective current.
- 38 - TRIPPING: the opening of a circuit breaker by actuation of the release mechanism.
- 39 - TRIP UNIT: a self-contained portion of a circuit breaker that is interchangeable and replaceable in a circuit breaker frame by the user. It actuates the circuit breaker release mechanism and it sets the RATED CURRENT ( $I_n$ ) of the circuit breaker unless a rating plug is used (to see also definition 32 RATING PLUG).



### Definitions from the Standards ANSI C37.13 and ANSI C37.17

- 40 - DIRECT-ACTING OVERCURRENT ELECTRONIC TRIP DEVICE<sup>(1)</sup>: a release or tripping system that is completely self contained in a circuit breaker and which requires no external power or control circuits to cause it to function, and is activated by means of analog or digital processing of a sampling of the current flowing through the circuit breaker. Information functions, if provided, may require external power and/or control circuits. The direct-acting overcurrent trip devices may include ground trip elements.
- 41 - RATED MAXIMUM VOLTAGE: the rated maximum voltage of a circuit breaker is the highest rms voltage, three-phase or single-phase, at which it is designed to perform. The circuit breaker shall be rated at one or more of the following maximum voltages: 635V, 508V, or 254V. For fused circuit breakers, the 635V rated maximum voltage becomes 600V to match the fuse rating.
- 42 - RATED FREQUENCY: the rated frequency of a circuit breaker is the frequency at which it is designed to perform. The standard frequency is 60Hz. Application at other frequencies should receive special consideration.
- 43 - RATED CONTINUOUS CURRENT: the rated continuous current of a circuit breaker is the designated limit of rms current at rated frequency that it shall be required to carry continuously without exceeding the temperature limitations designated in Section 7 (in ANSI C37.13). The preferred continuous current ratings of the various frame sizes are listed in ANSI C37.16-1988. The rated continuous current of a circuit breaker equipped with direct-acting trip devices or fuses of a lower rating than the frame size of the circuit breaker is determined by the rating of those devices.

<sup>(1)</sup> In this document the direct-acting overcurrent electronic trip device, installed in the Low Voltage Power Circuit Breakers, is called electronic trip unit.



## 3. ABB SACE Low Voltage Circuit Breakers complying with the Standards UL 489 and UL 1066

### 3.1 Generalities on Low Voltage Circuit Breakers

An electric plant shall be protected by the damages which may result from overcurrents. An overcurrent can be divided into:

- Short circuit (see definition 33 Chapter 2);
- Overload (see definition 25 Chapter 2).

In both cases (short circuit as well as overcurrent), the cables overheat and, if there are no adequate protections, the anomalous temperature rise damages the electrical plant and the connected equipment, with the risk of causing fires and then serious damages to people and things.

Among the devices used as protection against overcurrents, there are circuit breakers which, in case of fault, open the circuit in a mode depending on their tripping characteristics and on the overcurrent value.

The circuit breaker is a mechanical switching device, capable of making, carrying, and breaking currents under normal circuit conditions and also, making and carrying for a specified time and breaking currents under specified abnormal circuit conditions such as those of short circuit.

Each circuit breaker is equipped with a trip unit which actuates the circuit breaker release mechanism and allows opening on the basis of the current flowing through it.

Two types of trip units are used in low voltage circuit breakers:

- thermomagnetic (thermomagnetic trip unit)
- electronic (electronic trip unit)

The thermomagnetic trip unit consists of two parts:

- the thermal trip unit: made up by a bimetal thermal device which actuates the opening of a circuit breaker with a delay depending on the overcurrent value; this trip unit is intended for the protection against overloads;
- the magnetic trip unit: made up by an electromagnet device, with fixed (fixed instantaneous trip) or adjustable (adjustable instantaneous trip) threshold, which actuates the instantaneous trip of the circuit breaker on a pre-determined overcurrent value (multiple of the  $I_n$ ) with a constant trip time (about some tens of milliseconds); this trip unit is intended for the protection against short circuit.

#### Thermomagnetic trip unit

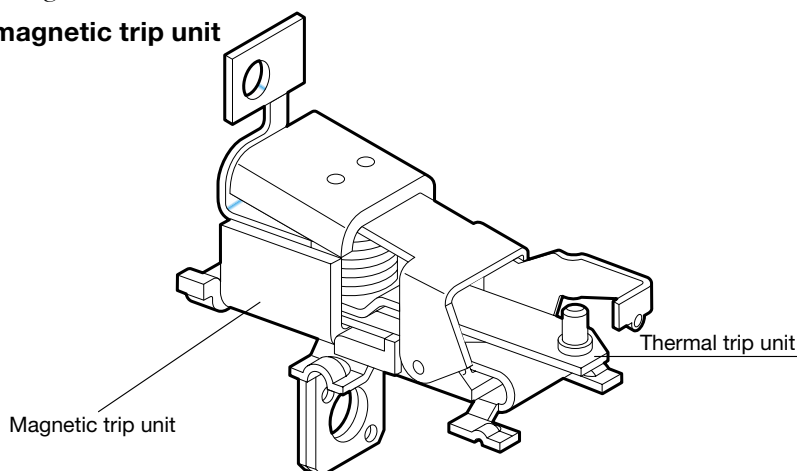

The electronic trip units instead use a microprocessor to process the current signal and operate the circuit breaker opening in case of fault. By digital processing of the signal, they provide the following protection functions:

- the long time-delay trip function (ANSI code: 51, ac time overcurrent relay);
- the short time-delay trip function (ANSI code: 51, ac time overcurrent relay);
- the instantaneous trip function (ANSI code: 50, instantaneous overcurrent relay);
- the ground-fault trip function (ANSI code: 51 N, ac time earth fault overcurrent relay).

### 3.2 ABB SACE Low Voltage Circuit Breakers

As regards the protection of low voltage installations, ABB SACE offers the following circuit breaker types:

- the Molded Case Circuit Breakers (MCCBs) of Tmax series, for rated currents from 15A up to 800A.
- the Low Voltage Power Circuit Breakers (LVPCBs) of Emax series, for rated continuous currents in a range from 400A to 5000A.

These devices are described hereunder, focusing, in the next chapter, on the trip units (thermomagnetic and electronic) with which they are equipped.

#### 3.2.1 Molded-Case Circuit Breakers (Tmax)

The circuit breakers of Tmax series (T1 1P, T1, T2, T3, T4, T5 and T6) are designed complying with the Standards UL 489 and can be applied in installations with currents from 15 to 800A, with rated voltages of 240V, 277V, 480V, 600Y/347V and 600Vac. Following the requirements of panel builders and installers, and consistently with the short circuit currents in the plant, Tmax CBs may be chosen among different types (B, N, S, H, L, V) to which a well determined interrupting rating corresponds (see definition 18 Chapter 2).



			Tmax T1 1P	Tmax T1	
<b>UL 489 CSA</b>					
Frame size	[A]		100	100	
Number of pole	[Nr]		1	3, 4	
Rated voltage	AC (50-60Hz)	[V]	277	600Y/347	
	DC	[V]		500	
Interrupting ratings			<b>B</b>	<b>N</b>	
	AC	240V [kA]		50 <sup>(2)</sup>	
		277V [kA]	18 <sup>(1)</sup>		
		480V [kA]		22 <sup>(2)</sup>	
		600Y/347V [kA]		10	
		600V [kA]			
	DC	250V - 2 poles in series [kA]		25	
		500V - 3 poles in series [kA]		25	
		500V - 2 poles in series [kA]			
		600V - 3 poles in series [kA]			
Trip units	TMF		■	■	
	TMD/TMA				
	ELT				
	MA				
Versions	MCCB		■	■	
	MCS			■	
	MCP				

<sup>(1)</sup> In 15A = 10kA @ 277V AC

<sup>(2)</sup> In 15A = 35kA @ 240V AC, 14kA @ 480Y/277V AC

TMF = Thermomagnetic trip unit with fixed thermal and magnetic threshold

TMD = Thermomagnetic trip unit with adjustable thermal threshold and fixed magnetic threshold

TMA = Thermomagnetic trip unit with adjustable thermal and magnetic threshold

MF = Magnetic fixed trip unit

MA = Magnetic adjustable trip unit

ELT = Electronic trip unit

#### UL 489 CSA C22.2

Dimensions	H	[in/min]	5.12/130	5.12/130	
	W 1p or 3p	[in/min]	1/25.4	3/76	
	W 4p	[in/min]		4/102	
	D	[in/min]	2.76/70	2.76/70	
Mechanical life		[No. operations]	25000	25000	
		[No. Hourly operations]	240	240	
Electrical life @ 415V AC		[No. operations]	8000	8000	
		[No. Hourly operations]	120	120	

In addition, the circuit breakers Tmax T2H, T4H, T4V, T5H and T5V, are also Current Limiting Circuit Breakers (see definition 5 Chapter 2).

In these devices, the system adopted for electric arc extinction allows high short circuit currents to be interrupted in very short times. The remarkable speed of contacts opening and the structure of the arcing chamber contribute to the extinction of the electric arc in the shortest possible time, thus limiting significantly the value of the let-through energy  $I^2t$  and granting to such devices the characteristics of the Current Limiting Circuit Breakers.

For single phase applications, the single-pole circuit breaker T1B 1P, with interrupting rating of 18kA at 277Vac, is available.

Tmax series molded case circuit breakers can be equipped with both thermomagnetic (TMF, TMD, TMA) as well as electronic (PR221DS, PR222DS/P and PR222DS/PD-A) trip units, whose main characteristics and functions shall be described in Chapter 4.

The molded case circuit breakers equipped with electronic trip units are not intended for dc systems.

The main characteristics of the protection devices of Tmax series are summarized in the following table:



Tmax T2		Tmax T3		Tmax T4					Tmax T5					Tmax T6			
100		225		250					400 - 600					800			
3, 4		3, 4		3, 4					3, 4					2, 3, 4			
480		600Y/347		600					600					600			
		500		600					600					600			
<b>S</b>	<b>H</b>	<b>N</b>	<b>S</b>	<b>N</b>	<b>S</b>	<b>H</b>	<b>L</b>	<b>V</b>	<b>N</b>	<b>S</b>	<b>H</b>	<b>L</b>	<b>V</b>	<b>N</b>	<b>S</b>	<b>H</b>	<b>L</b>
65	100	50	65	65	100	150	200	200	65	100	150	200	200	65	100	200	200
35	65	25	35	25	35	65	100	150	25	35	65	100	150	35	50	65	100
		10	10														
				18	25	35	65	100	18	25	35	65	100	20	25	35	42
		25	35														
		25	35														
				25	35	50	65	100	25	35	50	65	100	35	35	50	65
				16	25	35	50	65	16	25	35	50	65	20	20	35	50
■		■		■													
■			■	■					■							■	
■			■	■					■							■	
■			■	■					■							■	
■			■	■					■							■	
5.12/130		5.9/150		8.07/205					8.07/205					10.55/268			
3.54/90		4.13/105		4.13/105					5.51/140					8.27/210			
4.72/120		5.51/140		5.51/140					7.24/184					11.02/280			
2.76/70		2.76/70		4.07/103.5					4.07/103.5					4.07/103.5			
25000		25000		20000					20000					20000			
240		240		240					120					120			
8000		8000		8000 (250A) - 6000 (320A)					7000 (400A) - 5000 (630A)					7000 (630A) - 5000 (800A)			
120		120		120					60					60			

### 3.2.2 Low Voltage Power Circuit Breakers (Emax)

The family of Low Voltage Power Circuit Breakers which ABB SACE offer, in compliance with Std. UL 1066, is formed by Emax CBs type E1, E2, E3, E4 and E6 which cover a range of currents from 400 to 5000A, at 635V (rated maximum voltage). These circuit breakers, with different levels of performance (B-A, N-A, S-A, H-A, V-A, L-A) and ampere ratings, are able to break short-circuit currents

#### Common data

Voltages		
Rated maximum voltage	[V]	635
Rated voltage	[V]	600
Test voltage (1 min. 50/60Hz)	[kV]	22
Frequency		
	[Hz]	50-60
Number of poles		
		3-4
Version		
		Fixed (F) - Draw out (W)



			Emax E1		Emax E2			
Level of performance			B-A	N-A	B-A	N-A	S-A	H-A
<b>Currents</b>								
<b>Frame size</b>		[A]	<b>800</b>	<b>800</b>	<b>1600</b>	<b>800</b>	<b>800</b>	<b>800</b>
		[A]	<b>1200</b>	<b>1200</b>		<b>1200</b>	<b>1200</b>	<b>1200</b>
		[A]				<b>1600</b>	<b>1600</b>	<b>1600</b>
		[A]						
		[A]						
Capacity of neutral pole for four-pole circuit breakers	[%Iu]		100	100	100	100	100	100
Rated short-circuit current								
	240V	[kA]	42	50	42	65	65	85
	480V	[kA]	42	50	42	50	65	85
	600V	[kA]	42	50	42	50	65	65
Rated short time current	[kA]		42	50	42	50	65	65
<b>Trip units</b>								
	PR121/P		■	■	■	■	■	■
	PR122/P		■	■	■	■	■	■
	PR123/P		■	■	■	■	■	■
<b>Trip times</b>								
Make time (max)	[ms]		80	80	80	80	80	80
Break time (<ST current) (max)	[ms]		70	70	70	70	70	70
Break time (>ST current) (max)	[ms]		30	30	30	30	30	12
<b>Overall dimensions</b>								
Fixed: H = 418 mm/16.46 in - D = 302 mm/11.89 in								
	W (3 poles/4 poles)	[mm]	296/386		296/386			
	W (3 poles/4 poles)	[in]	11.65/15.2		11.65/15.2			
Draw out: H = 461 mm/18.15 in - D = 396.5 mm/15.61 in								
	W (3 poles/4 poles)	[mm]	324/414		324/414			
	W (3 poles/4 poles)	[in]	12.76/16.3		12.76/16.3			
<b>Weights</b> (Circuit breaker complete with trip unit, RH terminals, CS, excluding accessories)								
Fixed	3 poles/4 poles	[kg]	45.54		50/61			
	3 poles/4 poles	[lbs]	99/119		110/134			
Draw out	3 poles/4 poles	[kg]	70/82		78/93			
	3 poles/4 poles	[lbs]	154/181		172/205			

\* four poles only.

			Emax E1 B-A/N-A		Emax E2 B-A/N-A/S-A/H-A		
Continuous current rating Iu	[A]		<b>800</b>	<b>1200</b>	<b>800</b>	<b>1200</b>	<b>1600</b>
Mechanical life with regular ordinary maintenance	[No. Operations x 1000]		20	20	20	20	20
Operation frequency	[Operations/hour]		30	30	30	30	30
Electrical life	[No. Operations x 1000]		10	10	10	10	10
Operation frequency	[Operations/hour]		30	30	30	30	30

up to 150kA at 240V and 480V and up to 100kA at 600V. Emax CBs are equipped exclusively with electronic trip units and for this reason they are used only in ac systems.

The main characteristics of the protection devices of Emax series are summarized in the following table:



Emax E3					Emax E4					Emax E6			
N-A	S-A	H-A	V-A		S-A	H-A	V-A	L-A	H-A/f *	H-A	V-A	L-A	H-A/f *
2000	800	800	800		3200	3200	3200	3200	3200	4000	4000	4000	4000
2500	1200	1200	1200		3600	3600	3600	3600	3600	5000	5000	5000	5000
	1600	1600	1600										
	2000	2000	2000										
	2500	2500	2500										
	3200	3200	3200										
100	100	100	100		50	50	50	50	100	50	50	50	100
65	85	85	125		85	100	100	150	100	125	125	150	125
50	65	85	125		65	85	100	150	85	85	125	150	85
50	65	85	100		65	85	100	100	85	85	100	100	85
50	65	65	85		65	85	100	100	85	100	100	100	100
■	■	■	■		■	■	■	■	■	■	■	■	■
■	■	■	■		■	■	■	■	■	■	■	■	■
■	■	■	■		■	■	■	■	■	■	■	■	■
80	80	80	80		80	80	80	80	80	80	80	80	80
70	70	70	70		70	70	70	70	70	70	70	70	70
30	30	30	30		30	30	30	30	30	30	30	30	30
	404/530					566/656			746		782/908		1034
	15.91/20.82					22.28/25.83			29.37		30.79/35.78		40.71
	432/558					594/684			774		810/936		1062
	17.01/21.97					23.39/26.93			30.47		31.89/36.85		41.81
	66/80					97/117			125		140/160		185
	145/176					214/258			276		308/353		408
	104/125					147/165			200		210/240		275
	229/275					324/363			441		463/529		607
Emax E3 N-A-S-A/H-A/V-A						Emax E4 S-A/H-A/V-A/L-A/H-A/f				Emax E6 H-A/V-A/L-A/H-A/f			
800	1200	1600	2000	2500	3200	3200		3600		4000		5000	
15	15	15	15	15	15	8	8			8	8		
30	30	30	30	30	30	30	30			30	30		
10	10	10	8	8	8	5	5			5	3		
30	30	30	30	30	30	30	30			30	30		

## 4. Thermomagnetic and Electronic Trip Units for ABB SACE Circuit Breakers

In this chapter the characteristics, the implemented protection functions and the trip curves of the thermomagnetic and electronic trip units mounted on ABB SACE circuit breakers are described.

### 4.1 Thermomagnetic Trip Units

Thermomagnetic trip units are devices which guarantee combined protection against overload and short-circuit.

This type of trip unit is used for: ac/dc power distribution, electrical machines protection (transformers, motors, generators) and capacitor protection.

ABB SACE thermomagnetic trip units are mounted on MCCBs Tmax only and implement the following protections:

#### 4.1.1 Overload Protection (L)

The protection against overloads is implemented by a thermal device with inverse time trip characteristic. Identified by the letter “L”, it is a protection that trips when the fault current exceeds threshold  $I_1$  either, adjustable or fixed, according to the type of trip unit.

The application range of this protection concerns all the installations which can be subject to low-value but long-time overcurrents, which are dangerous for the life of equipment and cables.

#### 4.1.2 Instantaneous Short Circuit Protection (I)

The protection against short circuit is implemented by a magnetic device with a trip time independent of the fault current value. Identified by the letter “I”, it is a protection that trips instantaneously when the fault current exceeds threshold  $I_3$  either, adjustable or fixed, according to the type of trip unit. This protection trips to eliminate quickly high value currents and its trip times cannot be set.

### 4.1.3 Thermomagnetic Trip Units for Tmax Circuit Breakers

As regards Tmax CBs, ABB SACE offers three different types of thermomagnetic trip units (TMF, TMD and TMA). The implemented protections and the trip thresholds are shown in the following table:

TMF	TMD	TMA
<p><b>Time-current curve</b></p>	<p><b>Time-current curve</b></p>	<p><b>Time-current curve</b></p>
<p><b>Trip unit front</b></p>	<p><b>Trip unit front</b></p>	<p><b>Trip unit front</b></p>
<ul style="list-style-type: none"> <li>- Overload protection "L" Thermal trip threshold: <math>I_1 = I_n</math></li> <li>- Short-circuit protection "I" Magnetic trip threshold: <math>I_3 = 10 \times I_n</math></li> </ul>	<ul style="list-style-type: none"> <li>- Overload protection "L" Thermal trip threshold: <math>I_1 = (0.7 \div 1) \times I_n</math></li> <li>- Short-circuit protection "I" Magnetic trip threshold: <math>I_3 = 10 \times I_n</math></li> </ul>	<ul style="list-style-type: none"> <li>- Overload protection "L" Thermal trip threshold: <math>I_1 = (0.7 \div 1) \times I_n</math></li> <li>- Short-circuit protection "I" Magnetic trip threshold: <math>I_3 = (5 \div 10) \times I_n</math></li> </ul>

For circuit breakers Tmax T2 and T3, magnetic only trip units, MA, with adjustable threshold, are also available; they, complying with Standard UL 508 "Industrial Control Equipment", can be used in a "Combination Motor Controller Type D" (Instantaneous-Trip Circuit Breaker + Magnetic Motor Controller + Overload Relay).

<b>MA</b>	<p><b>Time-current curve</b></p>	<p><b>Trip unit front</b></p>	<ul style="list-style-type: none"> <li>- Short-circuit protection "I" Magnetic trip threshold: <math>I_3 = (6 \div 12) \times I_n</math></li> </ul>
-----------	----------------------------------	-------------------------------	---

#### 4.1.3.1 Time-Current Curve of a Thermomagnetic trip unit TMA

The curve, linked to the constructional characteristics of the Trip Unit, can be obtained through experimental tests and is graphically shown, in bilogarithmic scale, in a Cartesian system where the current  $I$  (in kA) and time  $t$  (in seconds) are plotted on the abscissa and on the ordinate respectively.

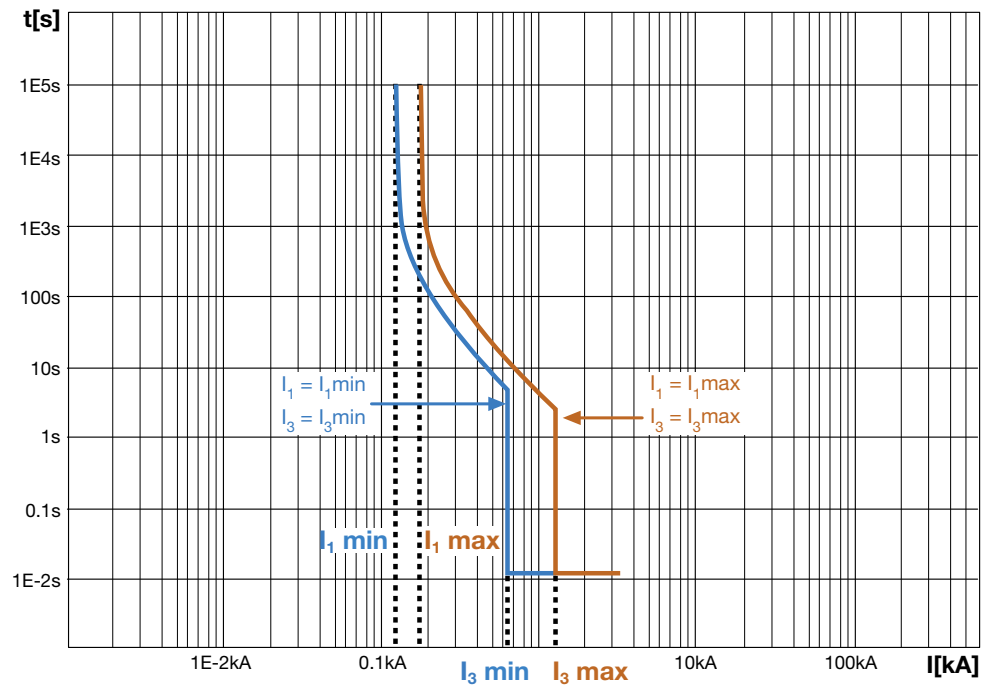

The graph shows two characteristic trip curves associated to the same trip unit TMA, where:

- the blue curve is that obtained by setting the thermal threshold  $I_1$  and the magnetic threshold  $I_3$  at their minimum value;
- the brown curve is that obtained by setting the two thresholds  $I_1$  and  $I_3$  at their maximum value.



### 4.1.3.2 Setting Examples of a Trip Unit TMA

The setting of the trip thresholds – thermal ( $I_1$ ) and magnetic ( $I_3$ ) - is obtained by acting on the relevant trimmers (see Figure 1).

As regards the setting of threshold  $I_1$ , known the current  $I_b$  absorbed by the load and the  $I_n$  of the trip unit, it results:

$$\text{Setting}_L = \frac{I_b}{I_n}$$

The available setting immediately higher than or equal to the obtained value shall be considered.

As regards the setting of threshold  $I_3$ , known the minimum short-circuit current  $I_{kmin}$  of the plant and the  $I_n$  of the trip unit, it results:

$$\text{Setting}_I = \frac{I_{kmin}}{I_n}$$

The available setting immediately lower than or equal to the value thus obtained shall be considered in order to satisfy the condition  $I_3 \leq I_{kmin}$ .

**Example:**

Circuit breaker T5N400  $I_n$  400 equipped with a TMA 400-4000

$I_b = 340A$

$I_{kmin} = 3000A$

$$\text{Setting}_L = \frac{340}{400} = 0.85 \rightarrow I_1 = 0.85 \times 400 = 340A$$

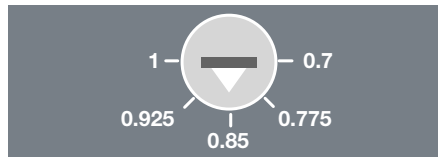

NOTE: this picture of the thermal threshold trimmer is for illustrative purpose only.

$$\text{Setting}_I = \frac{3000}{400} = 7.5 \rightarrow I_3 = 7.5 \times 400 = 3000A$$

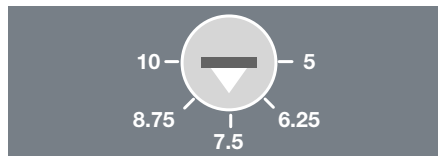

NOTE: this picture of the thermal threshold trimmer is for illustrative purpose only

Figure 1: Front of the trip unit TMA 400-4000

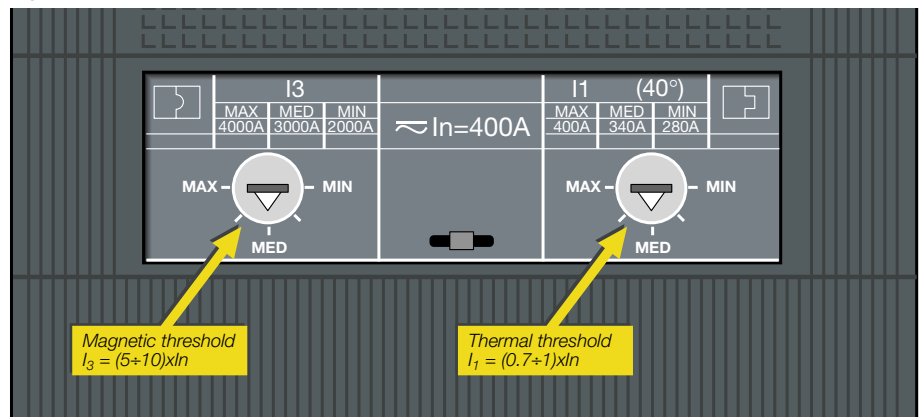

## 4.2 Electronic Trip Units

Electronic trip units are devices which guarantee a system of protection based on microprocessor electronics.

In comparison with thermomagnetic trip units, they allow a more precise setting both in terms of trip times as well as in terms of current thresholds in order to meet better the installation requirements.

ABB SACE electronic trip units, which can be mounted on Tmax and Emax CBs, implement the following protection functions:

### 4.2.1 Overload Protection (L)

Protection against overloads (long time delay trip function, ANSI code 51, ac time overcurrent relay), is identified by Function L. If the fault current exceeds the set threshold  $I_1$ , this protection trips according to an inverse time characteristic, where the link time-current is represented by the relation  $I^2t = K$  (constant let-through energy); with this curve, the tripping time decreases as the current increases.

$I_1$  represents the adjustable value of the trip threshold of the thermal protection and it is called long time pickup. This protection cannot be excluded.

The inverse time characteristic curve of function L is graphically represented, in bilogarithmic scale, by a line with negative slope as shown in Figure 2.

**Figure 2: Trip curve with inverse time curve ( $I^2t = K$ ) of protection L of a Tmax**

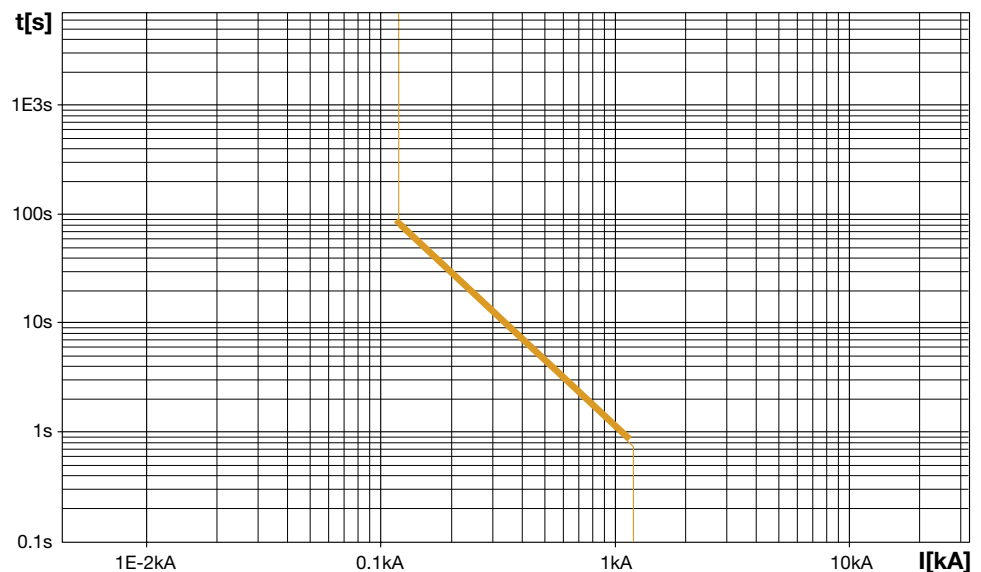

The electronic trip unit makes available a pencil of trip curves for Function L; more precisely, this pencil of curves is a bundle of parallel lines. Each line is identified by a time  $t_1$  (the long time delay) which represents the trip time of the protection, in seconds, in correspondence with a multiple of  $I_1$ . This multiple depends on the trip unit and is equal to  $3 \times I_1$  for Emax CBs and  $6 \times I_1$  for Tmax CBs.

To explain this concept, take into consideration a molded-case circuit breaker Tmax T4N250, equipped with an electronic trip unit PR222DS/P In 100, set at  $I_1=1\times I_n=100\text{A}$  ( $6\times I_1=600\text{A}$ ). PR222DS/P makes available four trip curves corresponding to a time  $t_1$  of 3, 6, 9 and 18s at  $6\times I_1$  (see Figure 3).

**Figure 3: Trip curves of function L of a trip unit PR222DS/P In 100**

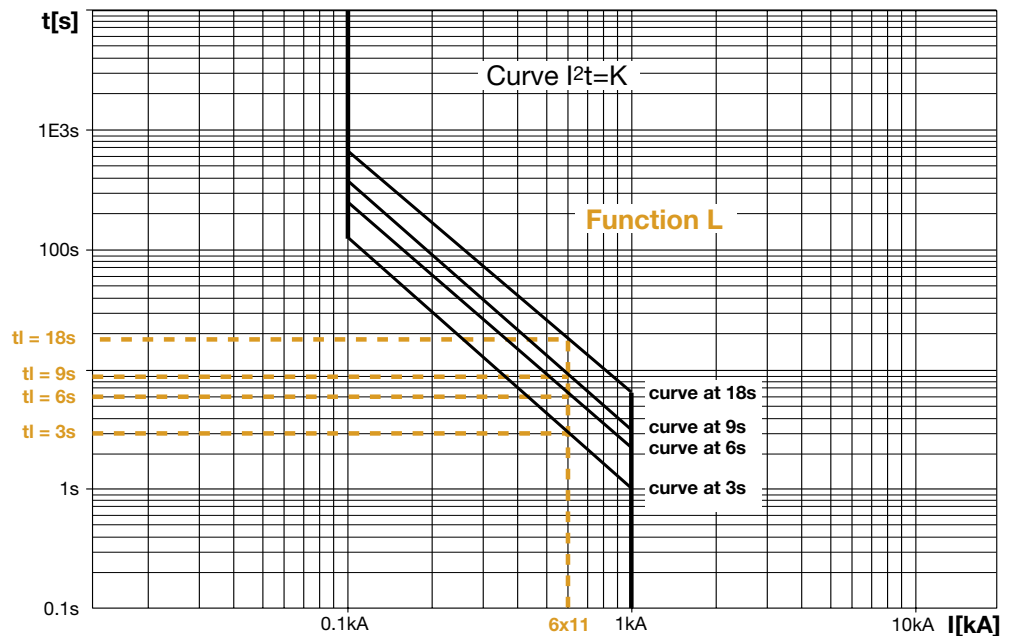

#### 4.2.2 Short Circuit Protection with Delayed Trip (S)

Protection against short circuit with time delay trip (short time delay trip function, ANSI code 51, ac time overcurrent relay), is identified by Function S. If the fault current exceeds the set threshold  $I_2$ , the protection trips with the following characteristic:

- with inverse time according to the relation  $I^2t = K$ : with this curve, the highest the fault current is, the shortest is the trip time;

or

- with constant time delay according to the relation  $t = K$ : with this curve the trip time is independent of the current.

$I_2$  represents the adjustable value of the protection trip threshold called short time pickup. This protection can be excluded.

#### Curves $t=K/I^2$ (constant let-through energy)

As regards the trend of the curve, from a conceptual point of view, the considerations made for protection L remain valid, except for the fact that the characteristic trip curve of protection S passes through a point  $(I,t)$  identified by the time  $t_2$  (the short time delay) which represents the trip time of the protection, in seconds, in

correspondence with a multiple of rated current  $I_n$ . This multiple of  $I_n$  depends on the trip unit and is equal to  $10 \times I_n$  for Emax and  $8 \times I_n$  for Tmax.

**Figure 4: Trip curves of function S ( $I^2t$  ON) of a trip unit PR222DS/P  $I_n$  250**

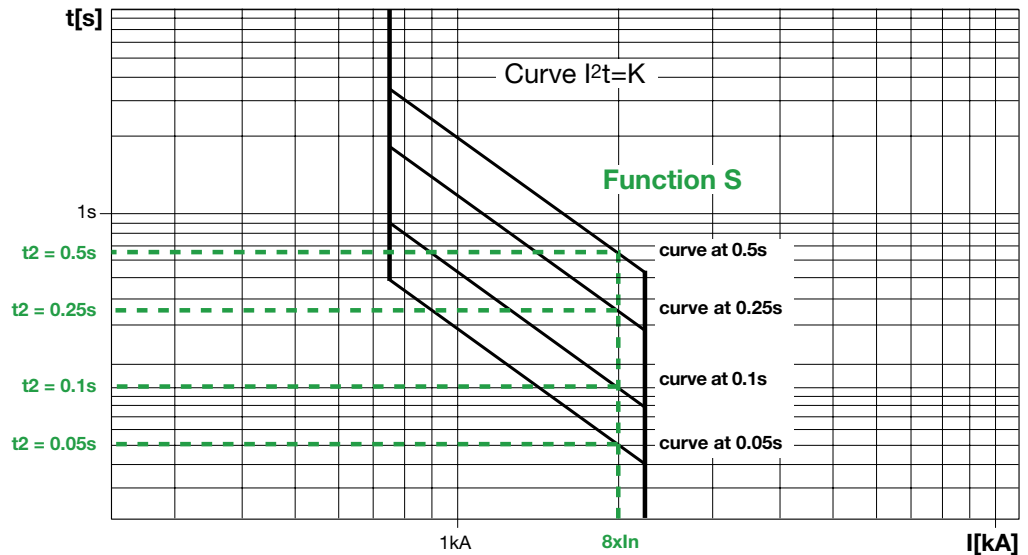

**Curves  $t=K$  (constant time)**

Protection S having trip curve with constant time delay is characterized by having the same short time delay,  $t_2$  (adjustable by the operator), for all the fault currents higher than or equal to the short time pickup,  $I_2$ .

Taking into consideration a circuit breaker Tmax T4N250 equipped with a trip unit PR222DS/P  $I_n$  100 put to OFF the curve  $I^2t=K$  of function S (thus, four trip curves at  $t=K$  become available, corresponding to a time  $t_2$  of 0.05, 0.1, 0.25 and 0.5s ).

Then set the following values for Function S:

$I_2 = 6.40 \times I_n = 6.40 \times 100 = 640A$  (short time pickup)

$t_2 = 0.10s$  (short time delay)

The curve which is obtained is shown with an orange line in Figure 5.

**Figure 5: Trip curves at 0.1s and 0.5s for function S ( $I^2t$  OFF) of a trip unit PR222DS/P  $I_n$  100**

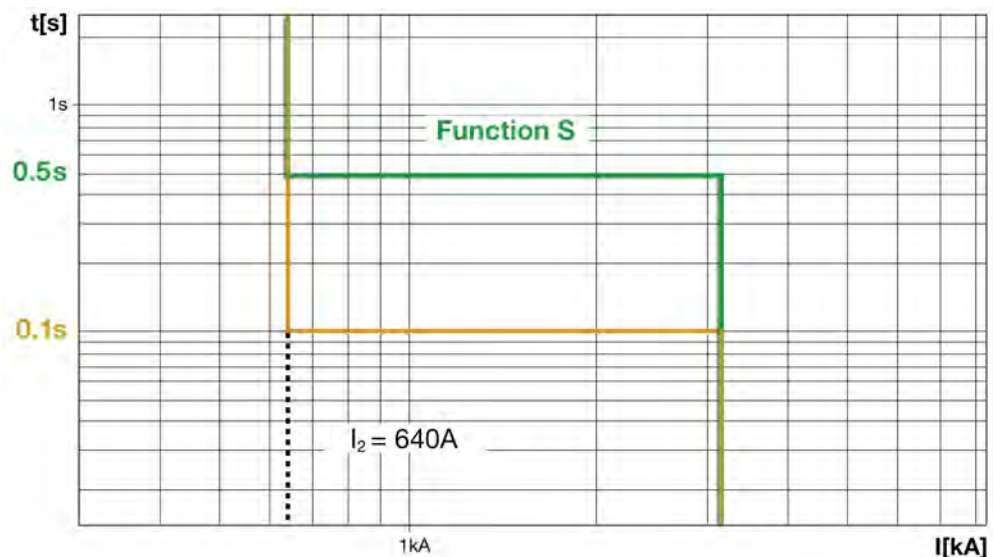

By changing the short time delay from 0.1s to 0.50s, the part of curve to be considered is the green one. For fault currents higher or equal to the threshold  $I_2$  of 640A, the protection function shall trip within the set time  $t_2$ .

For an example of curve reading see Chapter 5.

### 4.2.3 Instantaneous Short Circuit Protection (I)

The instantaneous protection against short circuit (instantaneous trip function, ANSI code 50, instantaneous overcurrent relay) is identified by Function I. If the fault current exceeds the set threshold value  $I_3$ , the protection actuates the instantaneous opening of the circuit breaker.

$I_3$  represents the adjustable value of the trip threshold of the protection, called instantaneous pickup setting.

If function I is excluded, in case of a short-circuit, the release mechanism will trip at the instantaneous override of the circuit breaker.

The part of curve associated to this protection is the blue one in Figure 6.

**Figure 6: Protection functions L-I**

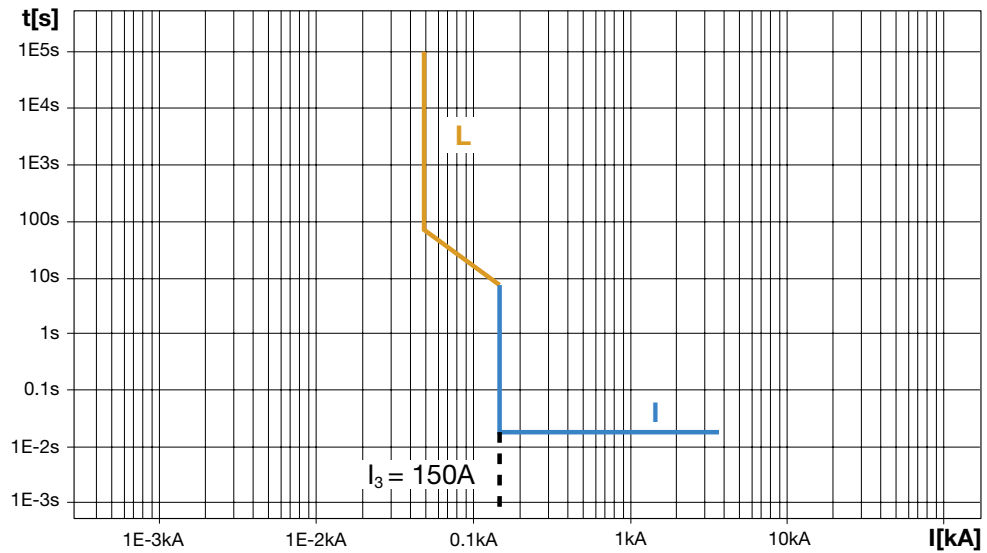

The graph represents the trip curve L-I of a circuit breaker Tmax T4N250 equipped with an electronic trip unit PR 222DS/P-LSIG In 100.

To find a reading example of the curve, refer to Chapter 5.

**Figure 7: Typical time-current curve for electronic trip circuit breaker ( $I^2t$  ON)**

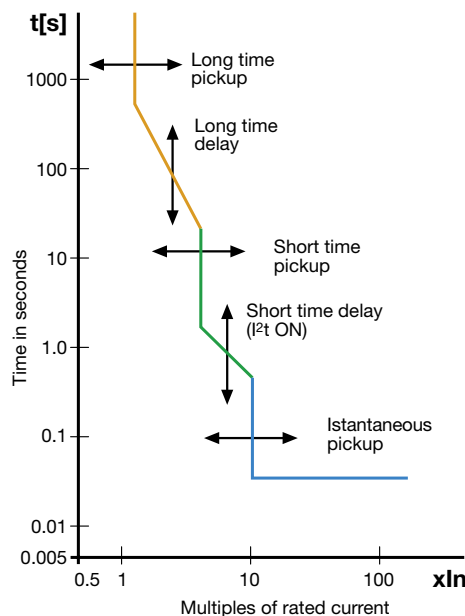

**Figure 8: Typical time-current curve for electronic trip circuit breaker ( $I^2t$  OFF)**

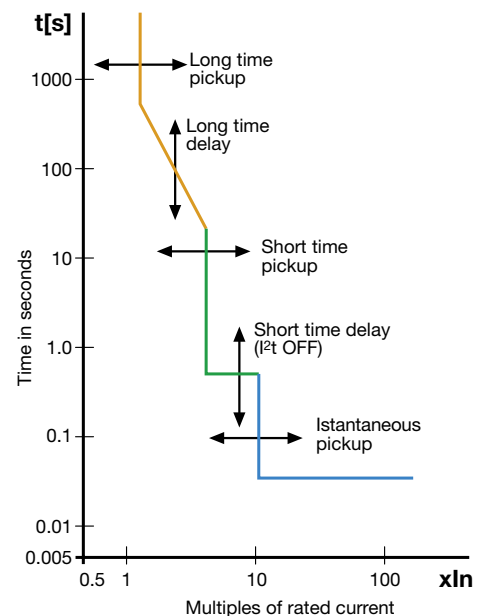

#### 4.2.4 Ground-Fault Protection (G)

The most advanced electronic trip units have an integrated protection against ground faults (ground-fault trip function, ANSI code 51 N, ac time earth fault overcurrent relay) identified with the Function G.

It is a protection against earth fault with curve  $I^2t = K$  or curve  $t = K$ . The parameters of this function are: the ground-fault pickup setting ( $I_4$ ) and the ground fault-delay ( $t_4$ ).

As regards the trip curves, whose trend is illustrated in Figure 9, the concepts previously mentioned for protection S are valid.

This function improves the conditions of protection against earth fault, since it allows to face all those situations in which the fault current has such values that phase protections (L, S, D) are not actuated.

Function G is deactivated for fault currents higher than a multiple of  $I_n$  (variable according to the trip unit).

This protection can be excluded.

**Figure 9: Trip curves of function G**

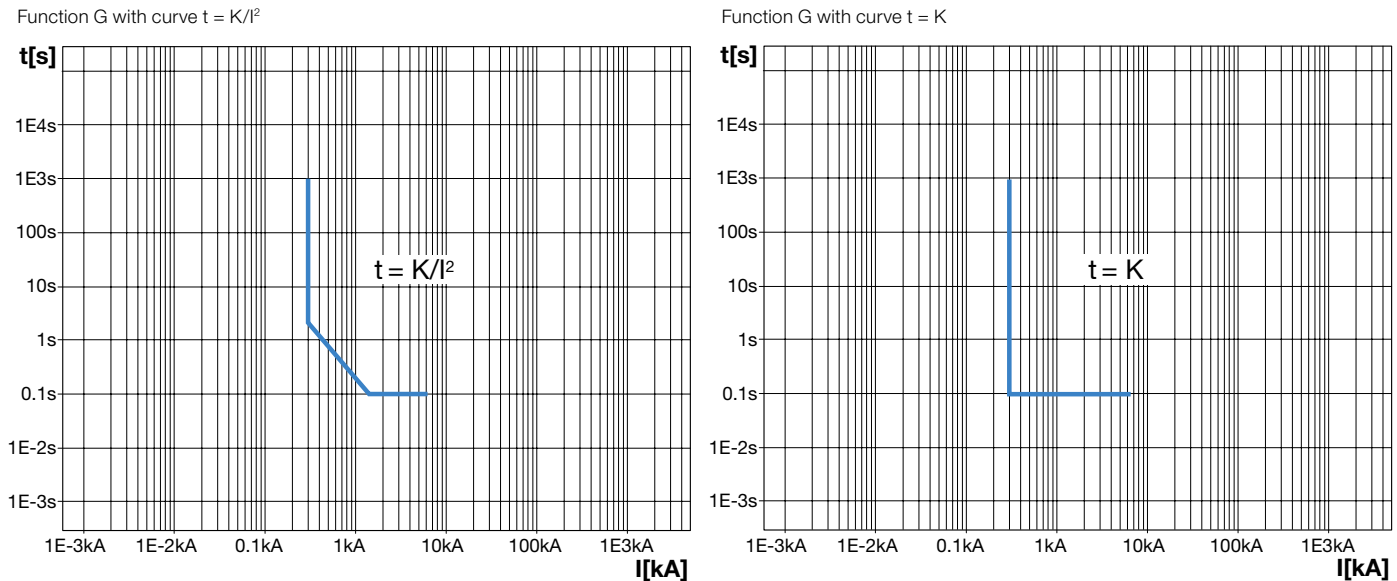

### 4.2.5 Electronic Trip Units for Tmax Circuit Breakers

For the circuit breakers of Tmax series, ABB SACE offers three different versions of trip units:

- PR221DS-LS/I for T2, T4, T5 and T6;
- PR222DS/P for T4, T5 and T6;
- PR222DS/PD-A for T4, T5 and T6, with the dialogue unit to allow the integration of the circuit breakers in a communication network based on the Modbus RTU protocol.

The implemented protection functions and their relevant trip thresholds are shown in the following table:

PR221DS-LS/I	PR222DS/P-LSIG	PR222DS/PD-A-LSIG
<p><b>Protection functions L-S-I</b></p> <p><b>Trip unit front</b></p> <p>Protection functions and trip threshold settings</p> <ul style="list-style-type: none"> <li>- L (cannot be excluded) <math>I_1 = (0.4 \div 1) \times I_n</math> curve: <math>I^2t = K</math></li> <li>- S (can be excluded) <math>I_2 = (1 \div 10) \times I_n</math> curve: <math>I^2t = K</math></li> <li>- I (can be excluded) <math>I_3 = (1 \div 10) \times I_n</math></li> </ul>	<p><b>Protection functions L-S-I</b></p> <p><b>Protection function G</b></p> <p><b>Trip unit front</b></p> <p>Protection functions and trip threshold settings</p> <ul style="list-style-type: none"> <li>- L (cannot be excluded) <math>I_1 = (0.4 \div 1) \times I_n</math> curve: <math>I^2t = K</math></li> <li>- S (can be excluded) <math>I_2 = (0.6 \div 10) \times I_n</math> curve: <math>I^2t = K</math> ON <math>I_2 = (0.6 \div 10) \times I_n</math> curve: <math>I^2t = K</math> OFF</li> <li>- I (can be excluded) <math>I_3 = (1.5 \div 12) \times I_n</math></li> <li>- G (can be excluded) <math>I_4 = (0.2 \div 1) \times I_n</math> curve: <math>I^2t = K</math></li> </ul>	<p><b>Protection functions L-S-I</b></p> <p><b>Protection function G</b></p> <p><b>Trip unit front</b></p> <p>Protection functions and trip threshold settings</p> <ul style="list-style-type: none"> <li>- L (cannot be excluded) <math>I_1 = (0.4 \div 1) \times I_n</math> curve: <math>I^2t = K</math></li> <li>- S (can be excluded) <math>I_2 = (0.6 \div 10) \times I_n</math> curve: <math>I^2t = K</math> ON <math>I_2 = (0.6 \div 10) \times I_n</math> curve: <math>I^2t = K</math> OFF</li> <li>- I (can be excluded) <math>I_3 = (1.5 \div 12) \times I_n</math></li> <li>- G (can be excluded) <math>I_4 = (0.2 \div 1) \times I_n</math> curve: <math>I^2t = K</math></li> </ul>

For Tmax T2, T4, T5 and T6 also the electronic trip units PR221DS-I are available; Complying with the Standard UL 508 “Industrial Control Equipment”, these units can be used in a “Combination Motor Controller Type D” (Instantaneous-Trip Circuit Breaker + Magnetic Motor Controller + Overload Relay).

<p><b>PR221DS-I</b></p>	<p><b>Time-current curve</b></p>	<p><b>Trip unit front</b></p>	<p><b>Protection function I</b></p> <p><math>I_3 = (1 \div 10) \times I_n</math></p>
-------------------------	----------------------------------	-------------------------------	--

#### 4.2.5.1 Setting Examples of a Trip Unit PR222DS/P

Taking into consideration a circuit breaker Tmax T4H250 In 150 equipped with an electronic trip unit PR222DS/P-LSIG

- the letter H identifies the interrupting rating of the circuit breaker which in the example under examination is 65kA at 480V;
  - 250A is the frame size of the circuit breaker;
  - In is the rated current of the circuit breaker which in this specific case is 150A.
- As an example let's consider now some generic settings for the protections L and I.

##### - setting of protection L

To set the threshold  $I_1$ , once the current  $I_b$  absorbed by the load and the  $I_n$  of the trip unit are known, it results:

$$\text{Setting}_L = \frac{I_b}{I_n}$$

The available setting immediately higher than or equal to the value obtained shall be taken.

By assuming that a load absorbing a current  $I_b$  of 69A must be protected, with a current  $I_n$  equal to 150A it results:

$$\text{Setting}_L = \frac{69}{150} = 0.46$$

To set the protection, the dip switches shall be moved to the position corresponding to 0.02 and 0.04 so that  $I_1 = I_n \times (0.4^* + 0.02 + 0.04) = 150 \times 0.46 = 69\text{A}$ .

To select, for example, the curve at 3s, the two dip switches corresponding to  $t_1$  shall be moved to the lowest position.

**Figure 10: Dip switch of function L**

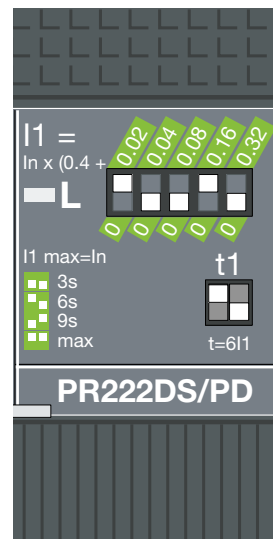

\* With function L, the value 0.4 is set by default and must be added to the other coefficients to obtain the correct value of  $I_1$ .



### - setting of protection I

To set the threshold  $I_3$ , once the minimum short-circuit current of the installation  $I_{K\min}$  and the current  $I_n$  of the trip unit are known it results:

$$\text{Setting}_I = \frac{I_{K\min}}{I_n}$$

The available setting immediately lower than or equal to the value obtained shall be taken to comply with the condition  $I_3 \leq I_{K\min}$ .

By assuming in the plant a minimum short circuit current  $I_{K\min} = 1500\text{A}$ , as a consequence of the above, the following results:

$$\text{Setting}_I = \frac{1500}{150} = 10$$

Then, according to the available settings, the following values shall be adjusted:

$$I_3 = 9.5 \times 150 = 1425\text{A}.$$

To obtain  $I_3 = 1425\text{A}$ , the dip switches shall be moved to correspond to 1.5, 3 and 5 so that:

$$I_3 = I_n \times (1.5+3+5) = 150 \times 9.5 = 1425\text{A}.$$

**Figure 11: Dip switch of function I**

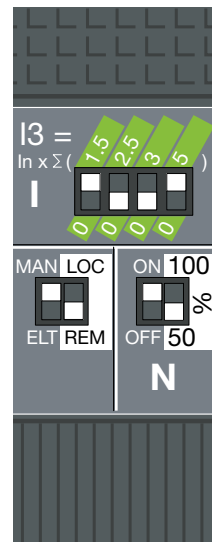

*NOTE: For more detailed information on thermomagnetic and electronic trip units for Tmax CBs, reference shall be made to the technical catalogue "ABB Molded Case Circuit Breakers UL 489 and CSA C22.2 Standard".*

### 4.2.6 Electronic Trip Units for Emax Circuit Breakers

For the circuit breakers of Emax series, ABB SACE offers three different types of electronic trip units (PR121/P, PR122/P, PR123/P). The implemented protection functions and their relevant trip thresholds are shown in the following table:

PR121/P L SIG	PR122/P L SIG	PR123/P L SIG
<p><b>Protection functions L-S-I</b></p>		<p><b>Protection function G</b></p>
<p><b>Trip unit front</b></p>	<p><b>Trip unit front</b></p>	<p><b>Trip unit front</b></p>
<p>Protection functions and trip threshold settings</p> <ul style="list-style-type: none"> <li>- L (cannot be excluded) <math>I_1 = (0.4 \div 1) \times I_n</math> curve: <math>t = K/I^2</math></li> <li>- S (can be excluded) <math>I_2 = (1 \div 10) \times I_n</math> curve: <math>t = K/I^2</math> <math>I_2 = (1 \div 10) \times I_n</math> curve: <math>t = K</math></li> <li>- I (can be excluded) <math>I_3 = (1.5 \div 15) \times I_n</math></li> <li>- G (can be excluded) <math>I_4 = (0.2 \div 1) \times I_n</math> curve: <math>t = K/I^2</math> <math>I_4 = (0.2 \div 1) \times I_n</math> curve: <math>t = K</math></li> </ul>	<p>Protection functions and trip threshold settings</p> <ul style="list-style-type: none"> <li>- L (cannot be excluded) <math>I_1 = (0.4 \div 1) \times I_n</math> curve: <math>t = K/I^2</math></li> <li>- S (can be excluded) <math>I_2 = (0.6 \div 10) \times I_n</math> curve: <math>t = K/I^2</math> <math>I_2 = (0.6 \div 10) \times I_n</math> curve: <math>t = K</math></li> <li>- I (can be excluded) <math>I_3 = (1.5 \div 15) \times I_n</math></li> <li>- G (can be excluded) <math>I_4 = (0.2 \div 1) \times I_n</math> curve: <math>t = K/I^2</math> <math>I_4 = (0.2 \div 1) \times I_n</math> curve: <math>t = K</math></li> </ul>	<p>Protection functions and trip threshold settings</p> <ul style="list-style-type: none"> <li>- L (cannot be excluded) <math>I_1 = (0.4 \div 1) \times I_n</math> curve: <math>t = K/I^2</math></li> <li>- S (can be excluded) <math>I_2 = (0.6 \div 10) \times I_n</math> curve: <math>t = K/I^2</math> <math>I_2 = (0.6 \div 10) \times I_n</math> curve: <math>t = K</math></li> <li>- I (can be excluded) <math>I_3 = (1.5 \div 15) \times I_n</math></li> <li>- G (can be excluded) <math>I_4 = (0.2 \div 1) \times I_n</math> curve: <math>t = K/I^2</math> <math>I_4 = (0.2 \div 1) \times I_n</math> curve: <math>t = K</math></li> </ul>

NOTE: For more detailed information on electronic trip units for Emax CBs, reference shall be made to the technical catalogue "Emax Low Voltage Power Circuit Breakers", marked UL.

## 5. Trip Curves of ABB SACE Trip Units

The following Chapter illustrates the trip curves of ABB SACE thermomagnetic and electronic trip units and gives some reading examples.

### 5.1 Trip Curves of Thermomagnetic Trip Units

Let's take into consideration a circuit breaker Tmax T4H250 In 250 equipped with a thermomagnetic trip unit TMA 250-2500.

Compatibly with the rated currents of the loads protected by the circuit breaker, with the short circuit currents calculated at its installation point and with the installation requirements, the settings of the protection functions are the following:

$I_1$ : 200A (overload protection)

$I_3$ : 2000A (short circuit protection)

Figure 12: Trip curve\* of Tmax T4H250 In 250

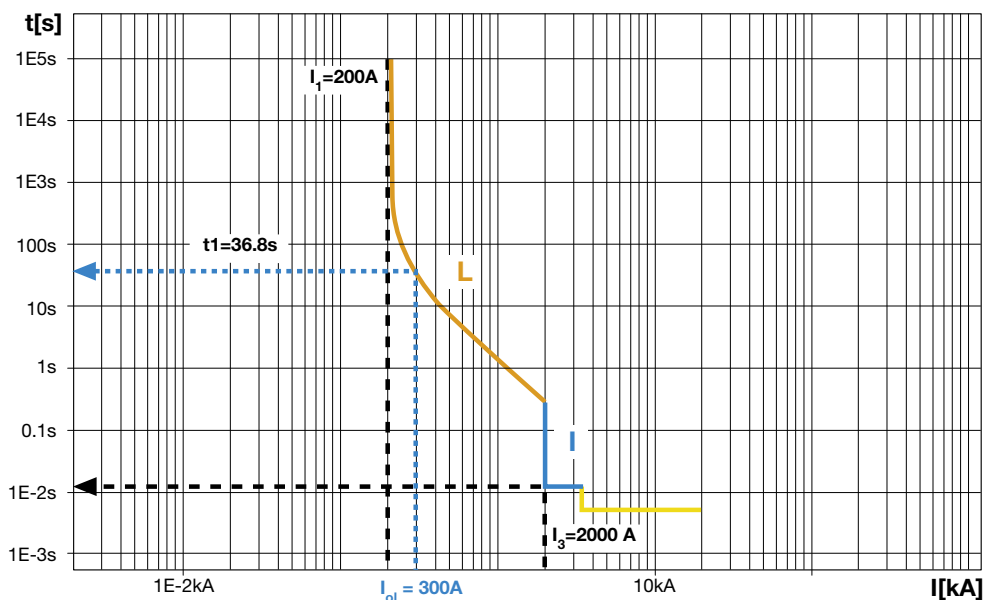

Assuming an overload current  $I_{oi}$  of 300A, the trip time of the circuit breaker can be read from the time-current curve as follows:

- 1) start from a current value  $I_{oi} = 300A$  on the x-axis
- 2) move vertically to the intersection with the time-current curve
- 3) from the intersection point move horizontally to the left to the intersection with the time-axis
- 4) the value read is the time  $t_1$ , which represents the extinction time of the overload; in this example it is:  $t_1 = 36.8s$ .

With fault currents exceeding 2000A (which is the set threshold  $I_3$ ), the circuit breaker shall open almost instantaneously (in some tens of milliseconds).

The yellow line represents the instantaneous override of the circuit breaker.

(\*) The time-current curve has been traced without considering the tolerances and under "hot trip conditions".

## 5.2 Trip Curves of Electronic Trip Units

### 5.2.1 Functions L and S

Curves  $t=K/I^2$  ( $I^2t$  ON) of Functions L and S

A circuit breaker Tmax T4H250 equipped with an electronic trip unit PR222DS/P-LSIG In 250 is considered; protection functions L and S are activated while protection I is not activated.

The curve  $I^2t = K$  of function S has been positioned to ON, whereas for function L such curve is set by default (see Chapter 4, clause 4.2.1 “Overload Protection (L)”); the trip curve of the circuit breaker is represented in Figure 13 (the yellow line is associated to the instantaneous override of the circuit breaker).

**Figure 13: Time-current curve of Tmax T4H250 PR222DS/P-LSIG In 250 ( $I^2t$  ON)**

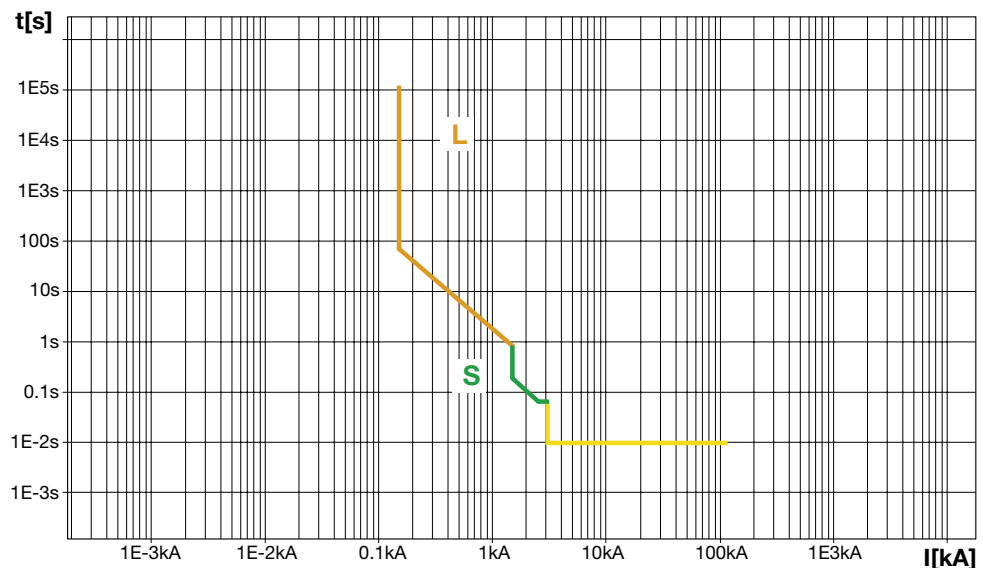

Describing in details function L and considering the following settings:

$$I_1 = 0.5 \times I_n = 0.5 \times 250 = 125\text{A (long time pickup)}$$

$$t_1 = 3\text{s (long time delay)}$$

here are some indications on how to read and what information get from the reading of the inverse time curve with constant let-through energy characteristic (from a conceptual point of view this is valid also for function S with curve  $I^2t = K$ ). Assuming a fault current  $I_{oi} = 375\text{A}$ , the clearing time of the fault can be read directly from the curve represented in Figure 14, as follows:

- 1) start from the fault current value  $I_{oi}$  on the horizontal axis
- 2) move vertically to the intersection with the time-current curve
- 3) from the intersection point move horizontally to the left to cross the time-axis
- 4) the value read is the time  $t_1$ , which represents the extinction time of the overload; in this example it is equal to 12s

**Figure 14: Curve - 3s - of Function L**

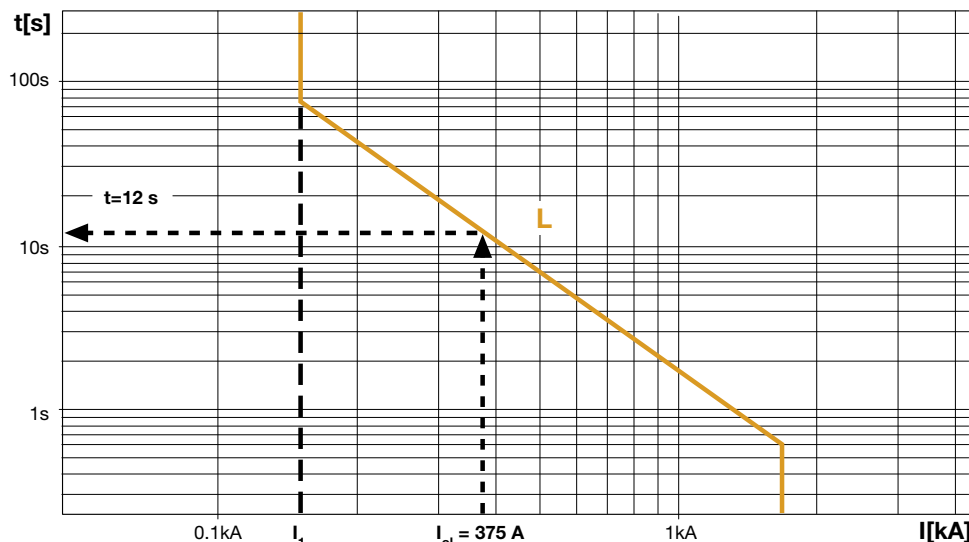

The time read directly on the graph can be obtained also analytically as follows. Since the curve under examination has  $I^2t$  constant, the condition below shall be always verified:

$$(6 \times I_1)^2 \times t_1 = \text{const} = I^2 \times t \quad (*)$$

(\*) This relationship is valid for overload currents up to  $12 \times I_n$ .

Where:

- the expression  $(6 \times I_1)^2 \times t_1$  is the specific let-through energy associated to the curve at 3s;
- the expression  $I^2 \times t$  represents the product between a generic overload current squared and the time necessary to the protection to open the circuit.

The trip time of the protection function for a fault current  $I_{ol} = 375\text{A}$  can be obtained as follows:

$$- (6 \times I_1)^2 \times t_1 = I_{ol}^2 \times t \quad \longrightarrow \quad t = \frac{(6 \times 125)^2 \times 3}{375^2} = 12\text{s} \quad \longrightarrow \quad t = 12\text{s}$$

If, for example, the installation requirements claim that the assumed overload of 375A is cut off in a time  $t_c$  lower than 15s, from the analysis carried out it shall result that the characteristic trip curve at 3s fully meets the requirement, because it ensures that the protection trips within 12s.

This conclusion can be drawn also in the following way:

from the relationship  $(6 \times I_1)^2 \times t_1 = I^2 \times t = \text{const}$ ;

for a fault clearing time  $t_c \leq 15\text{s}$

it results:  $(6 \times I_1)^2 \times t_1 = 375^2 \times t_c$

from which:  $(6 \times 125)^2 \times t_1 = 375^2 \times 15$

to obtain the time  $t$  (maximum trip time delay to comply with the installation requirements)

$$t = \frac{375^2 \times 15}{(6 \times 125)^2} = 3,75\text{s}$$

The suitable curve is that with " $t_1$ " lower than " $t$ "; therefore the curve to use is that at 3s. The reasoning above can be applied to function S with curve at  $I^2t = K$  ( $I^2t$  ON).

**Curves  $t = K (I^2t \text{ OFF})$  of function S**

Now take into consideration the previous example, but with the curve of protection S set at constant time  $t=K (I^2t \text{ OFF})$ ; in this case the time-current curve obtained is the following:

**Figure 15: Time-current curve of Tmax T4H250 PR222DS/P-LSIG In 250 ( $I^2t = K \text{ OFF}$ )**

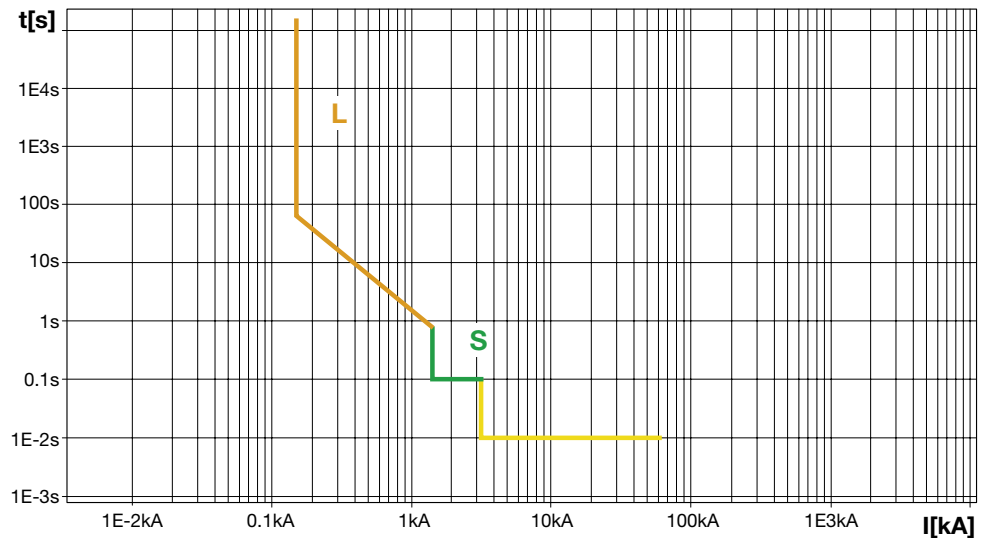

By setting a generic value for function S:

$$I_2 = 5.80 \times I_n = 5.80 \times 250 = 1450\text{A (short time pickup)}$$

$$t_2 = 0.10\text{s (short time delay)}$$

if a short circuit occurs, all the overcurrents  $I_g$  higher than or equal to  $I_2$  shall be cut off within the time  $t_2$ , as it can be read from the graph of Figure 16 as follows:

- 1) start on the x-axis from a fault current value  $I_g$  (in Figure 16  $I_g = 2000\text{A}$ )
- 2) move vertically to the intersection with the time-current curve
- 3) from the intersection point move horizontally to the left to cross the time-axis
- 4) the value read is the time  $t_2$ , which represents the fault extinction time; in this example  $t_2=0.1\text{s}$ .

**Figure 16: Function S at  $t = 0.1\text{s}$**

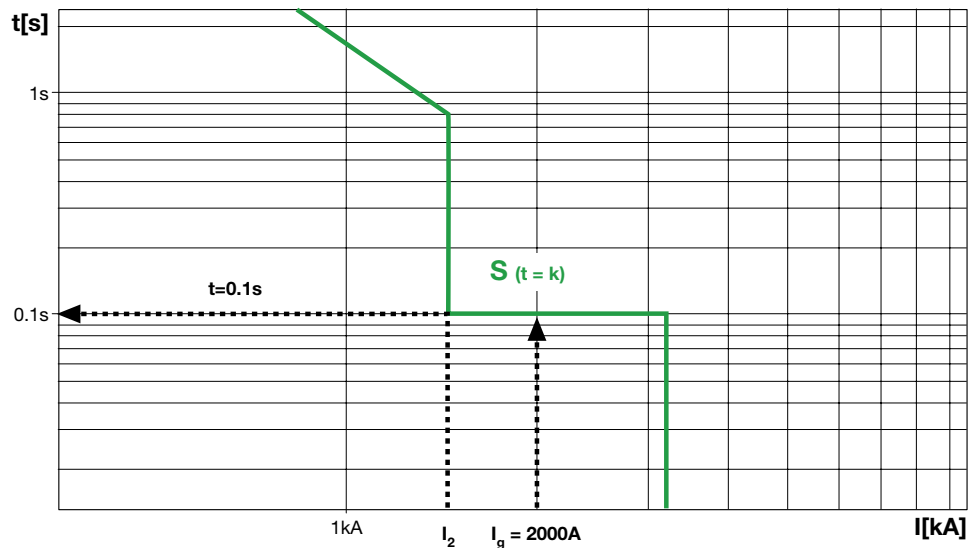

### 5.2.2 Function I

By considering again a circuit breaker Tmax T4H250 equipped with a trip unit PR222DS/P-LSIG In 250 and setting as an example the following values:

- Function L (long time-delay trip function):  
 $I_1 = 1 \times I_n = 1 \times 250 = 250\text{A}$  (long time pickup)  
 Curve: 3s (long time delay)
- Function S (short time-delay trip function):  
 OFF
- Function I (instantaneous trip function):  
 $I_3 = 7 \times I_n = 7 \times 250 = 1.75\text{kA}$  (instantaneous pickup setting)

the characteristic trip curve obtained is represented in Figure 17.

**Figure 17: Tmax T4H250 PR222DS/P-LSIG In 250**

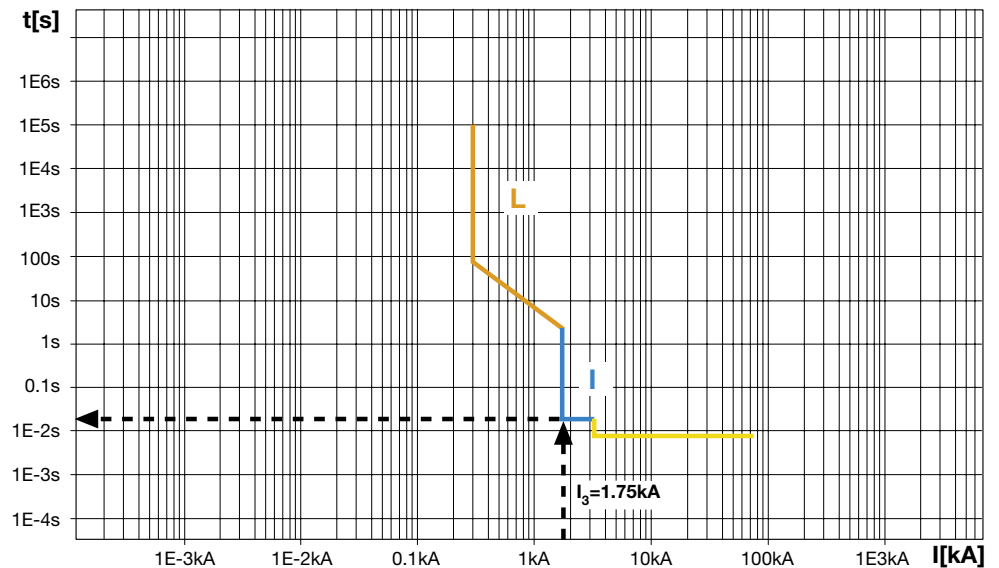

All the short-circuit currents exceeding 1.75kA shall be cut off in some milliseconds. The yellow line represents the instantaneous override of the circuit breaker.

### 5.2.3 Function G

For the protection against indirect contact, function G against ground-fault is available.

Here are two reading examples of the curves associated with this protection function, first the characteristic trip curve with  $I^2t = K$  and then the characteristic trip curve with  $t = K$  are examined.

A circuit breaker Emax E1B 1600 equipped with a trip unit PR122P-LSIG  $I_n = 1600A$  is taken into consideration.

#### Curves $I^2t = K$

The settings of function G are:

Characteristic  $I^2t = K$ : ON

Threshold:  $I_4 = 0.20 \times 1600 = 0.32kA$  (ground-fault pickup setting)

Curve:  $t_4 = 0.10s$  (ground fault-delay)

The characteristic curve obtained is represented in Figure 18.

**Figure 18: Function G at  $t = K/I^2$**

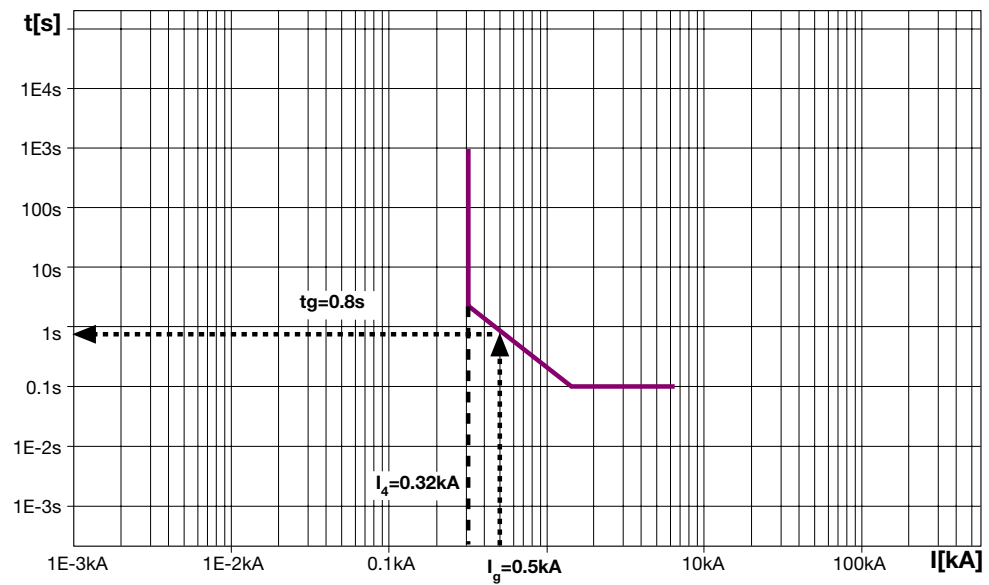

With a prospective fault current  $I_g = 0.5kA$  on the x-axis move vertically to the intersection with the curve; from this intersection point move to the left to cut the time-axis. The value read is the fault clearing time  $t_g$ ; in this example  $t_g = 0.8s$ .



### Curves $t = K$

The settings of function G are:

Characteristic  $I^2t = K$ : OFF

Threshold:  $I_4 = 0.20 \times 1600 = 0.32\text{kA}$  (ground-fault pickup setting)

Curve:  $t_4 = 0.10\text{s}$  (ground-fault delay)

The characteristic trip curve obtained is represented in Figure 19.

**Figure 19: Function G at  $t = K$**

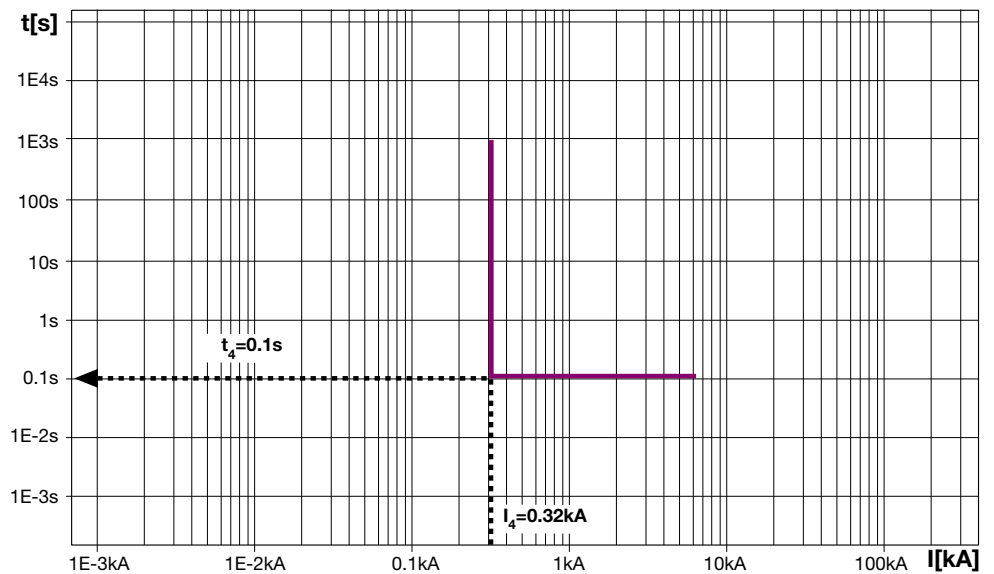

As it results from the reading of the graph, the ground fault currents exceeding the set threshold  $I_4 = 0.32\text{kA}$  shall be quenched in a time  $t_4$  equal to  $0.1\text{s}$ .

#### NOTES:

- 1) As regards the protection functions just described, for more detailed information on the possible settings of the thresholds and the trip times and on the possible curves available with electronic trip units on Tmax and Emax CBs, reference is to be made to the relevant technical catalogues by ABB SACE.
- 2) The time-current curves used in the examples of this chapter have been plotted without considering the tolerance over trip thresholds and times. For a thorough analysis please refer to Annex A.

## 6. Curves of Current Limiting Circuit Breakers: Let-Through Values of $I^2t$ and Peak Current

For the molded-case circuit breakers marked “Current Limiting”, the limitation curves of the peak current and of the energy let-through by the device have been made available.

These curves of the type shown in Figures 20 and 21, once the available short-circuit current is known, allow to determine:

- the maximum peak let-through current (from the limitation curves)
- the let-through  $I^2t$  value (from the specific let-through energy curves).

Figure 20: Specific let-through energy curve

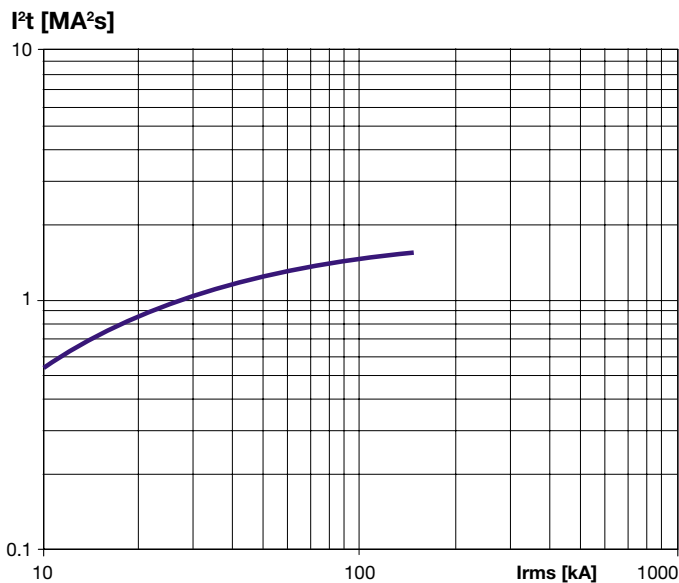
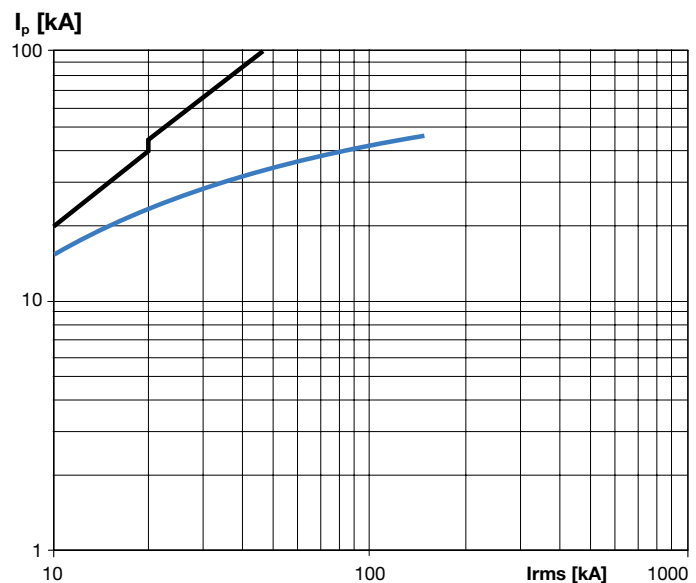

Figure 21: Limitation curve



The limitation curves are associated to the voltage value applied to the circuit breaker; in general, for the same available short circuit current, if the voltage applied is higher, the limiting capacity of the device shall decrease, thus letting through a higher peak current and  $I^2t$ .

These curves are made available by the manufacturer of the circuit breakers for each rated voltage of the device. Their use is prescribed in the Standard UL 508A “Industrial Control Panels” and in particular in the supplement SB: SHORT CIRCUIT CURRENT RATINGS FOR INDUSTRIAL CONTROL PANELS.

From the limitation curves the peak value let-through and/or the  $I^2t$  value can be determined as follows:

- 1) choose the curves corresponding to the proper rated voltage.
- 2) select the available short circuit current along the horizontal axis.
- 3) move vertically to the intersection with the curve corresponding to the rated current of the trip unit.
- 4) move horizontally left to the intersection with the vertical axis to determine the peak let-through current or  $I^2t$  value.

Consider a circuit breaker Tmax T4H250 equipped with a trip unit PR222DS/P-LSIG In 250; by assuming an available short-circuit current of 20kA at the installation point, we obtain the peak current and the let-through energy by reading them on their relevant limitation curves

### Specific let-through energy curve

With a rated voltage of 480V in the plant, the following curves are available:

**Figure 22: Specific let-through energy curves @ 480V**

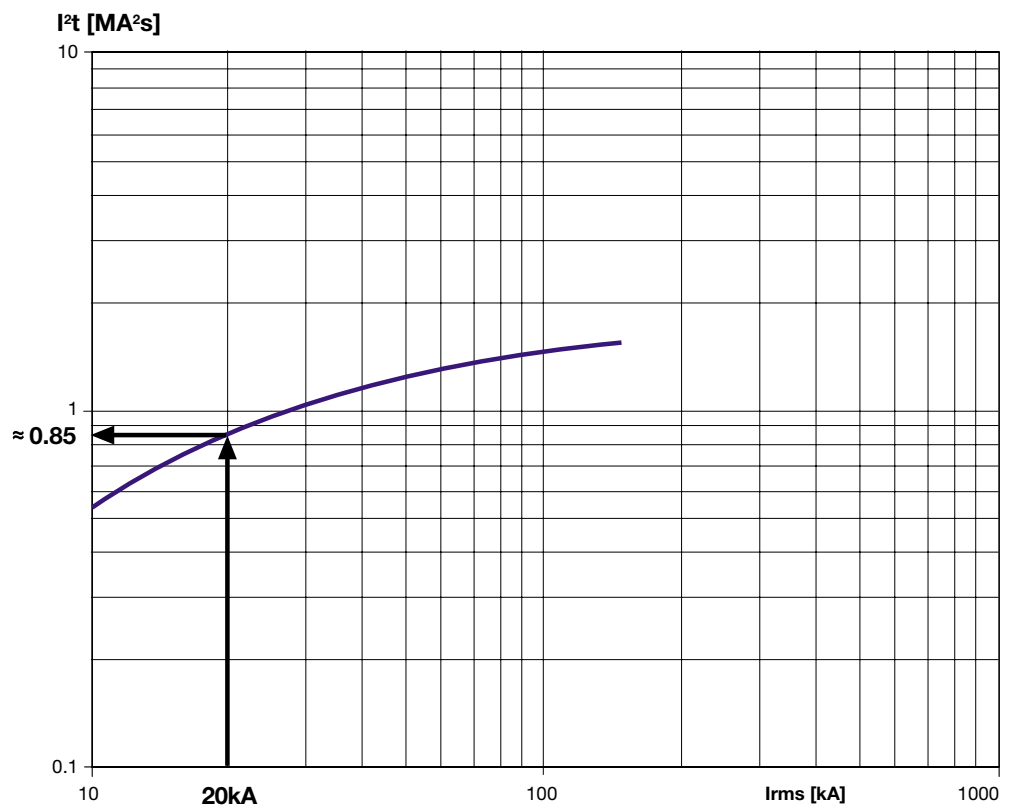

As it can be read in the graph, corresponding to an available short-circuit current of 20kA, the energy let-through by the circuit breaker is about 0.85MA<sup>2</sup>s.

**Limitation curve**

With a rated voltage of 480V in the plant, the following curves are available:

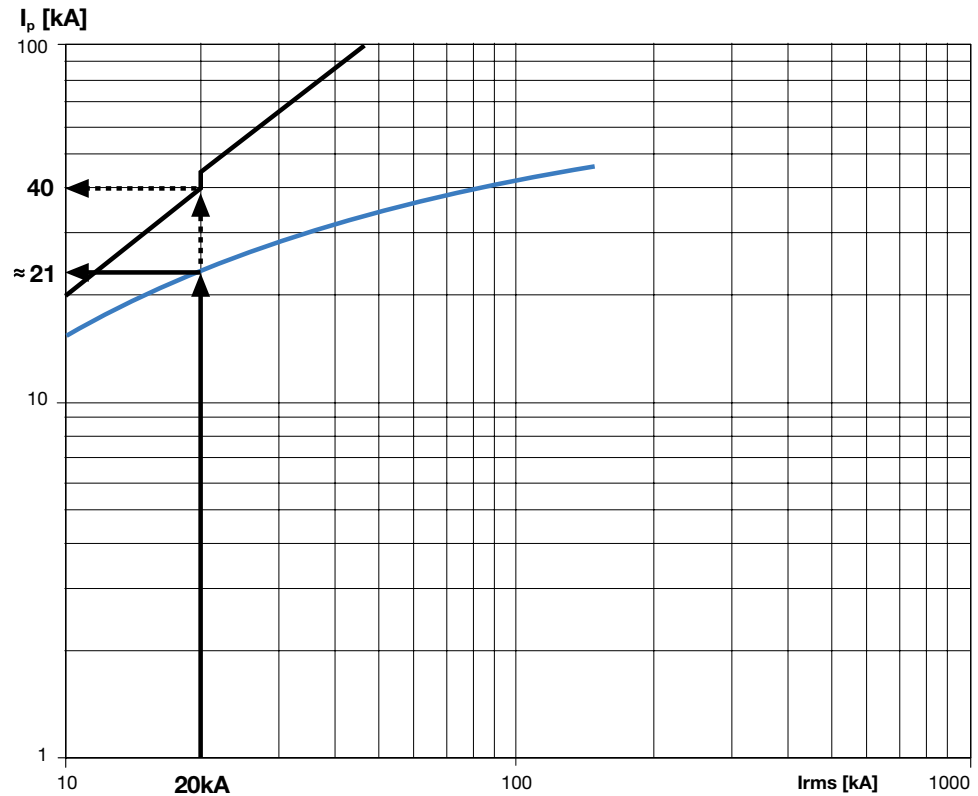
**Figure 23: Limitation curve of T4 250 at 480V**

For an available short circuit current of 20kA, the peak value let-through by the circuit breaker is about 21kA.

As it can be noted, with 20kA of available short circuit current, without the limiting action of the circuit breaker, there would have been a peak let-through current of 40kA.

It is important to make clear that the limiting effect of a circuit breaker does not influence its choice from the point of view of its interrupting rating since the adequate interrupting rating of a circuit breaker is chosen according to the prospective short-circuit current calculated at its installation point and according to the voltage of the plant, without considering the limitation of the current peak introduced by the circuit breaker itself. In fact, the equipment and the components which shall take advantage of the limiting effect of the circuit breaker are those on the load side.

## Annex A: Tolerance in the Trip Curves

The time-current curves used in the examples of Chapter 5 have been traced without taking into consideration the tolerance over the currents and the trip times.

The tolerance is the range within which a protection function can operate. All the electronic trip units have, for each protection function, a well defined tolerance. As a consequence, their tripping is represented by two curves: the first curve reports the highest trip times (upper curve) while the other one reports the fastest trip times (lower curve).

By considering a circuit breaker Tmax T4H250 equipped with a trip unit PR222DS/P-LSIG In 250 and fixing these settings:

- Function L (long time delay trip function):  
 $I_1 = 1 \times I_n = 1 \times 250 = 250\text{A}$  (long time pickup)  
 curve: 3s (long time delay)
- Function S (short time-delay trip function)  $t = K$ :  
 $I_2 = 5.80 \times I_n = 5.80 \times 250 = 1450\text{A}$   
 $t_2 = 0.50\text{s}$
- Function I (instantaneous trip function):  
 OFF

protection function S can be analyzed as follows:

the green curve represents the real characteristic trip curve of the trip unit, including tolerances ( $I_2 \pm 10\%$  and  $t_2 \pm 10\%$ ); the red curve represents instead the trip curve traced without keeping into account the tolerance values.

With the set values it results:

- for fault currents ranging from  $I_2 - 10\%$  and  $I_2 + 10\%$  (tolerance over the trip threshold), protection S shall trip with a delay time  $t_2$  from 0.45 to 4.75s;
- for faults currents exceeding  $I_2 + 10\%$ , protection S shall trip with a delay time  $t_2$  from 0.45 to 0.55s (tolerance over the trip times).

This can be observed also by reading the curve in Figure 24.

**Figure 24: Tolerances of function S at  $t = K$**

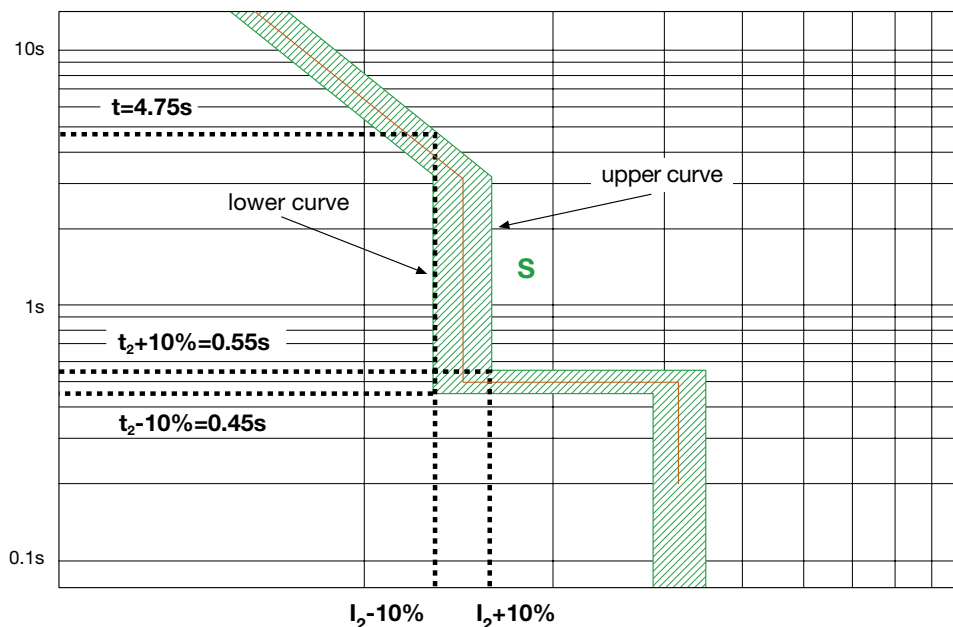

## Glossary

<b>TMF</b>	thermomagnetic trip unit with fixed thermal and magnetic thresholds
<b>TMD</b>	thermomagnetic trip unit with adjustable thermal threshold and fixed magnetic threshold
<b>TMA</b>	thermomagnetic trip unit with adjustable thermal and magnetic thresholds
<b>MA</b>	magnetic only trip unit with adjustable threshold
<b>Function L</b>	overload protection (long time-delay trip function)
<b>Function S</b>	short-circuit protection with delayed trip (short time delay trip function)
<b>Function I</b>	instantaneous short-circuit protection (instantaneous trip function)
<b>Function G</b>	ground-fault protection (ground-fault trip function)
<b><math>I_n</math></b>	rated current of the circuit breaker
<b><math>I_1</math></b>	long time pickup
<b><math>t_1</math></b>	long time delay
<b><math>I_2</math></b>	short time pickup
<b><math>t_2</math></b>	short time delay
<b><math>I_3</math></b>	instantaneous pickup setting
<b><math>I_4</math></b>	ground-fault pickup setting
<b><math>t_4</math></b>	ground-fault delay
<b><math>I_{rms}</math></b>	available short-circuit current
<b><math>I_p</math></b>	peak current
<b><math>I^2t</math></b>	specific let-through energy
<b>CBs</b>	Circuit Breakers
<b>K</b>	Constant





---

**ABB SACE S.p.A.**

An ABB Group Company

*L.V. Breakers*

Via Baioni, 35

24123 Bergamo - Italy

Tel.: +39 035.395.111 - Telefax: +39 035.395.306-433

**<http://www.abb.com>**

Due to possible developments of standards as well as of materials, the characteristics and dimensions specified in this document may only be considered binding after confirmation by ABB SACE.

1SDCC007400G0201 September '07  
Printed in Italy  
5.000/0c6 Facility Services SPA/ICAL